

fischertechnik



TRAINING FACTORY

INDUSTRY 4.0 V2

Accompanying booklet

567769
01.12.2022

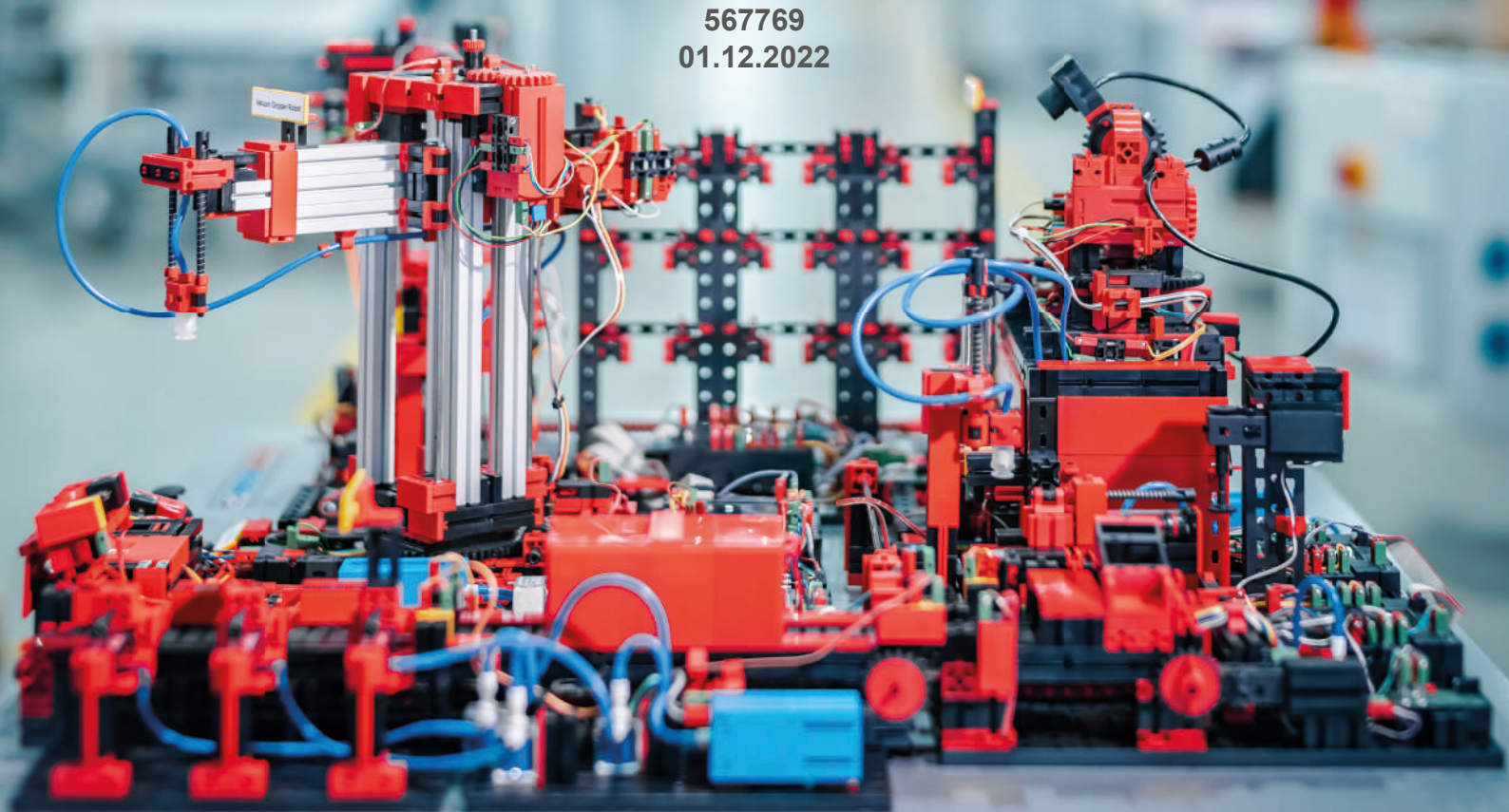

Contents

Introduction	p. 4
Porting the Training factory 4.0 9V to the Training factory 4.0 9V V.2	p. 5
First steps	p. 6
Factory operation	p. 7
The individual factory components	p. 8
Vacuum gripper	p. 8
Automated high-bay warehouse	p. 9
Environmental sensor	p.10
Multi processing station with furnace	p.10
Sorting line with colour detection	p.11
Environmental station monitoring camera	p.13
Multi processing station with monitoring camera	p.14
Environmental sensor and photoresistor	p.14
Input / output station with colour detection and NFC reader	p.15
Block diagram of the factory system display controller	p.16
Block diagram of the local factory system	p.18
fischertechnik Node-Red Dashboard for the Training Factory	p.19
Block diagram of the factory system with internet connection	p.22
Training Factory dashboard in the fischertechnik Cloud	p.23
User registration	p.24
Cloud connection	p.25
Factory dashboard	p.27
Camera dashboard	p.30
Environmental station dashboard	p.31
Factory operation tasks	p.34
Task 1	p.34
Task 2	p.36
Task 3	p.39
Task 4	p.39
Task 5	p.40
Task 6	p.42
Task 7	p.43
Task 8	p.44

Contents

Component description	p.45
Encoder motor	p.45
Mini-motor	p.45
Compressor	p.46
3/2-way solenoid valve	p.46
Pneumatic cylinder	p.47
Vacuum cup	p.47
Mini button	p.47
LED	p.48
LED light barrier	p.48
LED light	p.48
Phototransistor	p.48
Environmental sensor	p.49
Colour sensor	p.49
TXT 4.0 Controller	p.50
NFC tags	p.51
NFC reader	p.51
Layout plans	p.52
Calibration	p.58
Updating programs	p.64

Introduction

Digitization in industrial production requires more networking and more intelligent information on every level of production. The fischertechnik Training Factory 4.0 can be used to simulate these digitization activities on a small scale, so that users can learn and apply them before implementing them in full-scale systems. The Training Factory is a highly flexible, modular, inexpensive, and robust training and simulation model that is simple and efficient to use.

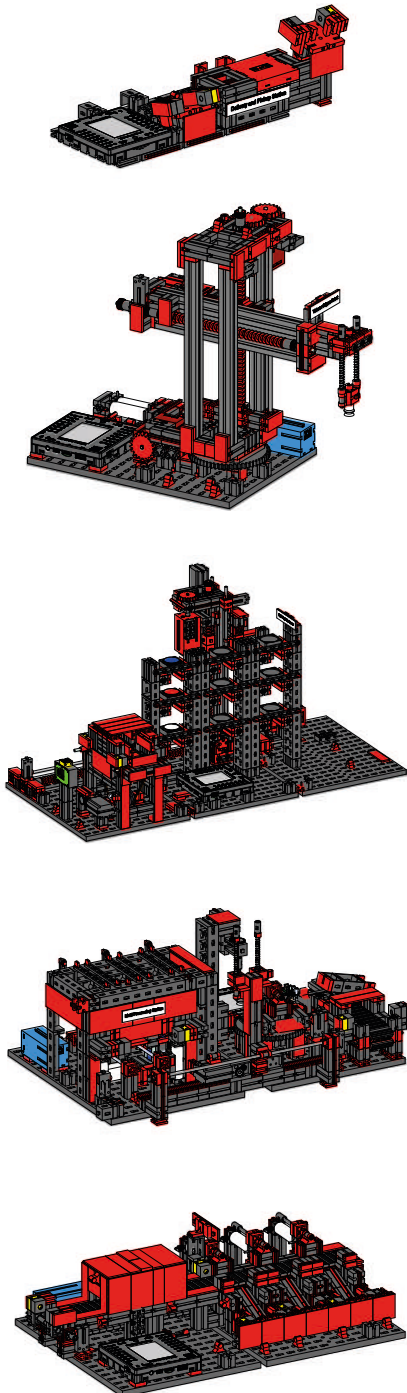

The fischertechnik learning environment is used for learning and understanding industry 4.0 applications in vocational schools and training as well as for research, teaching and development at universities, in companies and IT departments. The simulation depicts the ordering process, the production process and the delivery process in digitised and networked process steps.

It consists of the factory modules like storage and retrieval stations, vacuum gripper, high-bay warehouse, multi-processing station with furnace, a sorting line with colour detection, an environmental sensor and a pivoting camera.

After the order has been placed in the dashboard, the workpieces pass through the respective factory modules and the current status is immediately visible on the dashboard. The integrated environmental sensor reports values for temperature, humidity, air pressure and air quality. The camera sees the entire system through the vertical and horizontal pan range and can thus be used for web-based remote monitoring.

Individual workpieces are tracked using NFC (Near Field Communication): A unique identification number (ID) is assigned to each workpiece. This enables the user to trace workpieces and view their current status in the machining process.

The Training Factory 4.0 is controlled by six fischertechnik TXT 4.0 Controllers, which are supplied by three 9V power supplies. These are connected in the factory by ribbon cables. One TXT 4.0 Controller serves as the master in this configuration, and the other 5 TXT 4.0 Controllers as extensions.



Porting the Training factory 4.0 9V to the Training factory 4.0 9V V.2

Training Factory 4.0 9V (551584)	Training Factory 4.0 9V V.2 (567769)
Hardware	
<p>6x TXT Controllers (5 masters / 1 extension)</p> 	<p>6x TXT 4.0 Controllers (1 master / 5 extensions)</p> 
TXT-I2C adapter	I2C adapter not required (integrated in the TXT 4.0 Controller)
Nano router	
2x Joysticks (calibration)	not required (calibration via local dashboard with Node-RED)
Software	
C/C++ programs	Robo Pro coding and Python programs
<p>Internet (internet router)</p> <ul style="list-style-type: none"> - Operation with fischertechnik Cloud - Additional device with web browser required - All functions 	<p>Internet (internet router)</p> <ul style="list-style-type: none"> - Operation with fischertechnik Cloud - Additional device with web browser - All functions <p>Local network (router)</p> <ul style="list-style-type: none"> - Local operation with Node-RED dashboard - Additional device with web browser required - Model calibration - All functions (calibration via Node-RED dashboard) <p>Model only (without router)</p> <ul style="list-style-type: none"> - Operation with TXT 4.0 display - No additional device required - Restricted functions <ul style="list-style-type: none"> - Order workpiece white/red/blue - Park factory / acknowledge errors - Display NFC tag

First steps

Once you have carefully unpacked the “Training Factory” and removed the transportation safety, carry out a visual inspection to see whether any components have become loose or damaged during transport. Attach any loose components back in the right place. To do so, compare your model with the 3D data set for the “Training Factory 9V V2”, which is available on the eLearning portal. Check whether all cables and hoses are connected. You can connect any disconnected cables correctly with the aid of the assignment diagrams.

Once any errors have been corrected, connect the system to the power network. The best option for doing so is a 5 outlet power strip with mains switch. You can use it to turn the system on and off.



Three 9V DC/2.5A power supplies are used to supply the TXT 4.0 Controller.



Each power supply is connected to one of the 3 DC mini adapters.

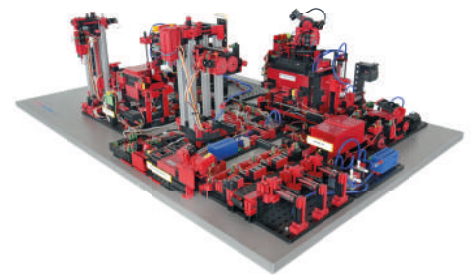
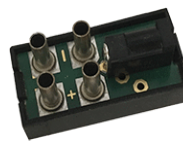

The position of the DC adapters is as follows:

DC adapter 1: For high-bay warehouse and sensor station on building panel 1 beside the blue compressor.

DC adapter 2: For sorting system and vacuum gripper between building panels 1 and 2 of the multi-processing station.

DC adapter 3: For multi-processing station on the 2nd building panel of the multi-processing station.



Switch the power supply on to test it. If the Auto Boot function is activated, all TXT 4.0 Controllers will be switched on and booted.



Then fit the high-bay warehouse with the 9 enclosed empty black containers.

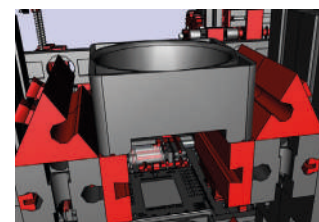

Factory operation

To start factory operation, now start the application on the TXT 0 Controller as described:

When the TXT 4.0 Controller is turned on, the programs are loaded automatically by the “Auto Load” and only need to be started.

Once the program has started, the Training Factory 4.0 is ready for use.

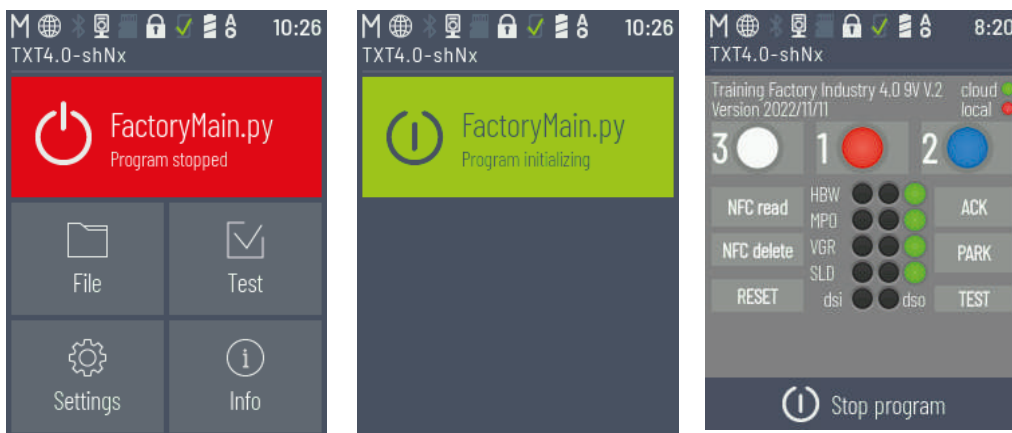

The program can also be stopped and manually restarted.

The individual factory components

This section introduces you to the individual components of the factory system, and briefly explains their functions.

What are robots?

The Verband Deutscher Ingenieure (VDI - Association of German Engineers) defines industrial robots as follows in VDI guideline 2860:

“Industrial robots are universally applicable automated machines with multiple axes whose movements can be freely programmed with respect to their sequence of motions and paths or angles of movement (e.g., without mechanical or human intervention), and that may be controlled by sensors. They can be equipped with grippers, tools, or other production materials, and can carry out handling and/or manufacturing tasks”.

Vacuum gripper 9V (VGR)

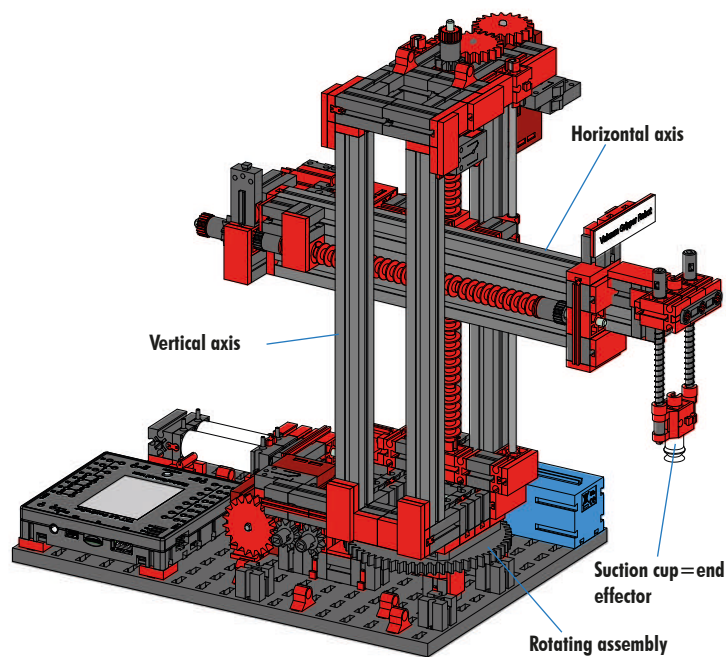

A 3 axis robot with vacuum gripper quickly and precisely positions workpieces in three-dimensional space. Working range: X axis 270°, Y axis (forward/back) 140 mm, Z axis (up/down) 120 mm.

The 3D vacuum gripper is, therefore, an industrial robot that can be used for handling tasks. Workpieces are picked up using the vacuum gripper and moved within a work area. This work area is determined based on the kinematic design of the robot, and it defines the range within which the robot end

effector can move. In the case of the vacuum gripper, the suction cup is the effector, and the work area corresponds to a hollow cylinder, the vertical axis of which coincides with the rotational axis of the robot.

The geometric shape of the work area is determined based on the kinematic design, which is shown in the figure and which is composed of one rotational and two translational axes.



Buttons

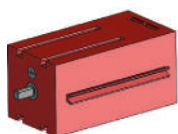

Encoder motor

The typical work order for a robot of this type can be divided into the following work steps:

- Positioning the vacuum gripper to the workpiece
- Picking up the workpiece
- Transporting the workpiece within the work area
- Setting down the workpiece

The movements to position the vacuum gripper or transport the workpiece can be defined as point-to-point movements or as a continuous path. The individual axes are activated sequentially and/or in parallel, and this activation is influenced primarily by the obstacles present in the work area or pre-defined intermediate stations. The vacuum gripper is controlled using a 3/2-way solenoid valve and two coupled pneumatic cylinders (to generate the vacuum pressure).

9V automated high-bay warehouse (HBW)

What is a high-bay warehouse?

A high-bay warehouse is a type of warehouse that saves floor space and makes it possible to move goods into and out of storage via a computer-supported process. In most cases, high-bay warehouses are designed as

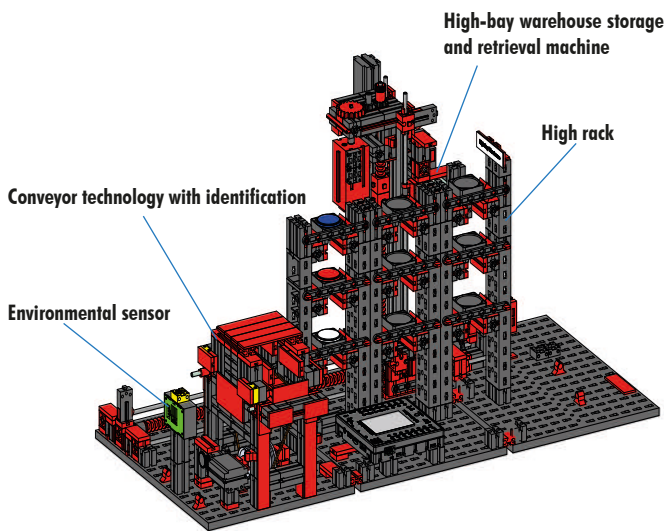

pallet racking systems. This standardisation allows for a high degree of automation and connection to an ERP system (enterprise resource planning). High-bay warehouses stand out for their good use of space and high required investment. Goods are moved into and out of storage using storage and retrieval machines which move along an aisle between two rows of shelves. This area is part of the incoming goods area, where goods are also identified. Conveyor technology such as a chain conveyor, roller conveyor or vertical conveyor is used to deliver the goods and transfer them to the storage and retrieval machines. If the storage and retrieval

machines are automated, then no personnel may stand in this area. If the high-bay warehouse is automated, then goods are delivered using a conveyor belt.



Compressor

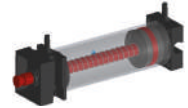

Cylinder

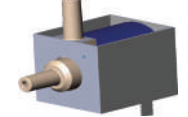

3/2-way solenoid valve



Suction cup



Phototransistor



Buttons



Mini-motor

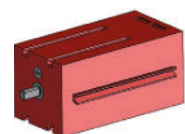

Encoder motor

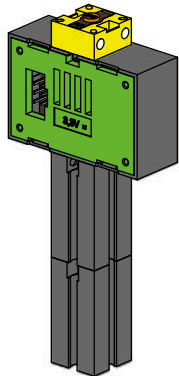

Environmental sensor (BME 680)

For technical reasons (space), the environmental sensor was installed on the base plate of the high-bay warehouse. The electrical connections are on the TXT 0, however.

Multi processing station with furnace 9V (MPO)

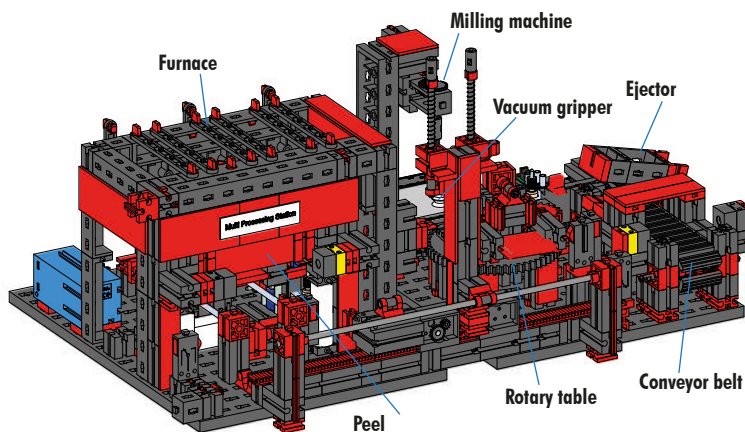

In the multi-processing station with furnace, the workpiece passes through multiple stations that simulate different processes in an automated fashion. Different conveyor technologies are used to do so, such as a conveyor belt, a rotary table and a vacuum gripper. The processing sequence starts with the furnace. The workpiece is placed on the peel to begin processing. This breaks the light barrier, which causes the door of the furnace to open and the peel to be pulled inside. At the same time, the vacuum gripper that moves the workpiece to the rotary table after the furnace process is activated. After the furnace process,

the door of the oven is opened once again and the peel is moved out. The vacuum gripper, which is already in place, picks up the workpiece, transports it to the rotary table, and sets it down there. The rotary table positions the workpiece under the milling machine, stays there during processing, and then moves the workpiece to the pneumatically activated ejector. This pushes the workpiece onto the conveyor belt, which moves the workpiece to a light barrier and then on to the sorting system. When the light barrier is broken, the rotary table moves back to its initial position and the conveyor belt is stopped at a time delay.



Mini-motor



Phototransistor



Buttons

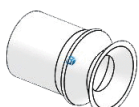

Suction cup

The multi-processing station with furnace is controlled using two TXT 4.0 Controllers.

Because of the large number of inputs and outputs, the program sequence runs in parallel. It is divided into three units: Furnace, vacuum gripper and rotary table. The individual processes communicate with one another, ensuring that collisions do not occur, among other functions.

The furnace triggers the movement of the vacuum gripper at two points in the program sequence, for instance. This ensures, on the one hand, that the vacuum gripper is in the right place at the right time, and, on the other, that it has something to grip. The rotary table is also activated after the vacuum gripper sets down the workpiece.

Sorting line with colour detection 9V (SLD)

The sorting line with colour detection is used to automatically separate workpieces of different colours. Components with identical geometry that are different colours are fed via a conveyor belt and then separated using a colour sensor. The conveyor belt is driven by an S motor, and the conveyor path is measured using a pulse button. The workpieces are ejected using pneumatic cylinders that are assigned to the relevant storage positions and activated using solenoid valves. Multiple light barriers check the flow of workpieces, and whether the workpieces are in the storage positions.

An optical colour sensor is used for colour detection. It radiates light, and uses the reflection of a surface to determine its colour. Strictly speaking, the colour sensor is a reflection sensor which indicates how well a surface reflects light. Therefore, the value measured by the sensor is not proportional to the wavelength of the measured colour, and it is not possible to assign colour coordinates or colour spaces (such as RGB or CMYK). In addition to the colour of the object, the ambient light, the surface of the object, and the distance between the object and sensor influence the quality of the reflection. Because of this, it is very important that the colour sensor be protected from ambient light and that the surfaces of the objects be comparable.



Compressor



Cylinder

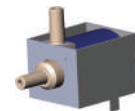

3/2-way solenoid valve

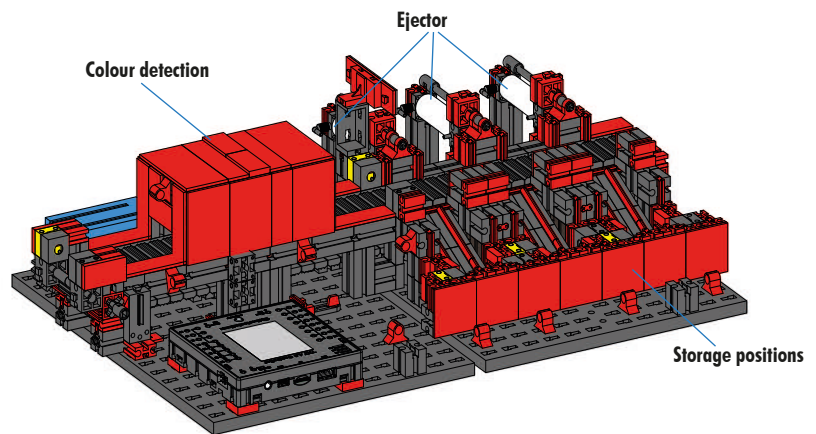

Compressor

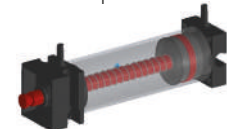

Cylinder

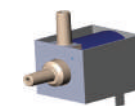

3/2-way solenoid valve



Buttons

In addition, it is important that the sensor is installed vertically to the surface of the object. The coloured workpieces are differentiated by threshold values that delineate the measured values for the individual colours. Since the value ranges for different colour sensors differ, these limit values always have to be adjusted.



Phototransistor

When a workpiece is placed on the conveyor belt and interrupts the light barrier, the process is started and the conveyor belt starts up. The workpiece passes through a darkened channel in which a colour sensor is installed in order to detect its colour. During this time interval, the minimum value for the measured colour values is determined and assigned to the workpiece. In the time that it takes the workpiece to move past the colour sensor, the previous minimum value is compared with the current measured value and replaced by it if necessary.



Mini-motor

The light barrier, which is upstream of the first ejector, is used to control ejection. The corresponding pneumatic cylinder is triggered at a delay after the workpiece interrupts the light barrier, depending on the detected colour value. The pulse button that registers the rotation of the gear that drives the conveyor belt is used for this purpose. In contrast to a time-based delay, this approach is not affected by disruptions in the conveyor belt speed. The ejected workpieces are guided into the respective storage positions by three chutes.

The storage positions are equipped with light barriers that detect whether the storage position is full or not. The light barrier, however, cannot determine how many workpieces are in the storage position.

Environmental station with monitoring camera (SSC)

The environmental station with monitoring camera is used to record measured values in the Factory. The mobile camera station is installed on the multi-processing station, and is used to visually monitor the system.

The environmental sensor and a photoresistor can be used to measure the air temperature, humidity, air pressure, air quality and brightness. The values are displayed graphically.

A virtual joystick can be used to turn and tilt the camera to monitor the factory. The images are also shown on the monitoring screen.

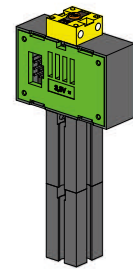
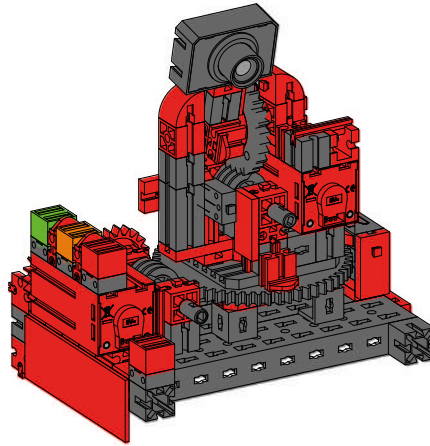

Photoresistor, environmental sensor

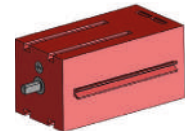
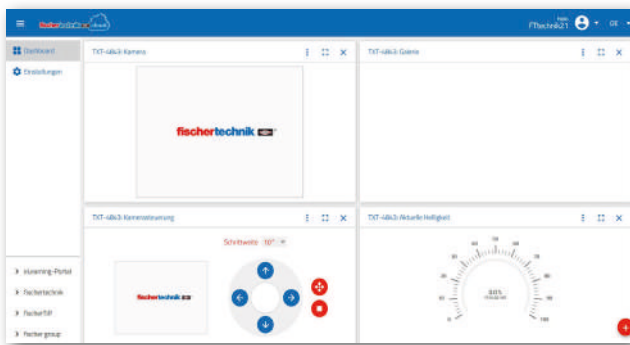

Encoder motor



Camera

The various sensor data can be continuously monitored and the movement axes of the camera can be controlled on an operating interface called a "Dashboard". The bottom red LED always lights up when a camera image is transferred to the cloud.

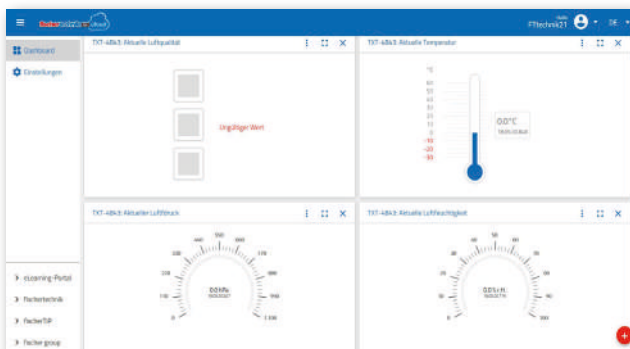

Multi processing station with monitoring camera

The two modules “Multi-processing centre and monitoring camera” are combined into one module in the factory system. The advantage of this is that the camera is at the highest point in the factory model, and can monitor the entire system.

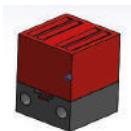
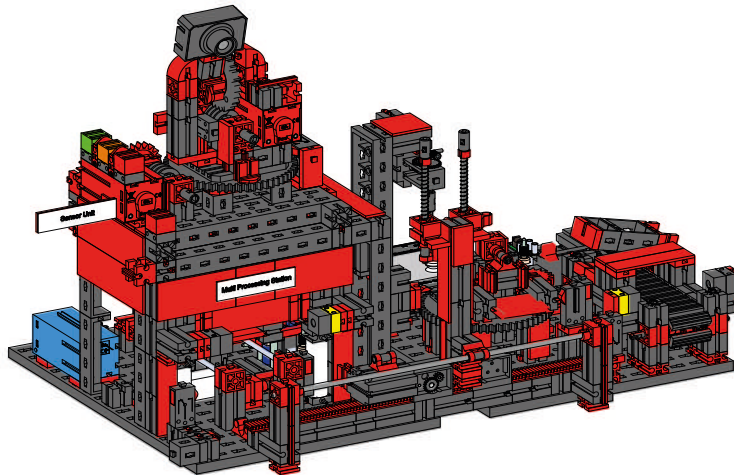

Red control light

The monitoring camera also has a visual indicator (red light). It flashes to show that images can be recorded.

Factory status indicator

The status of the factory is indicated by three LEDs.

Green means that all stations are in waiting status.

Yellow means that at least one station is active.

Red means an error that must be acknowledged in the Dashboard in the Cloud before the Training Factory can continue the sequences.



Status indicator

Environmental sensor and photoresistor

The environmental sensor and photoresistor are located on the high-bay warehouse module. They are both connected to the Controller, which also controls the camera.

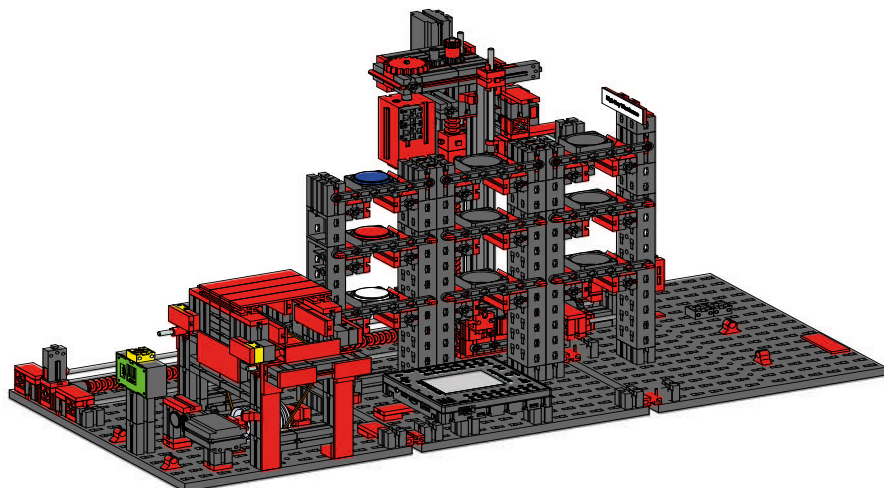

Input / output station with colour detection and NFC reader

The input / output station consists of a total of 4 work areas:

- Input and output unit (1,4)
- Colour detection (2)
- NFC reader (3)

The light barrier in the input station detects whether there is a workpiece inside the station that needs to be stored. If there is, then the information is transmitted to the next steps in the program (vacuum gripper picks up the workpiece).

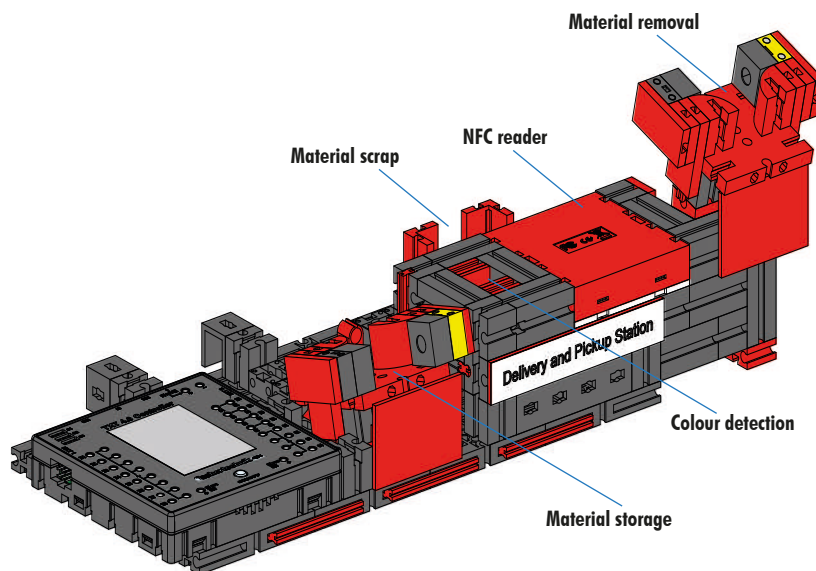

Before the workpiece is processed further, a colour sensor determines the colour of the workpiece in the colour detection.



Phototransistor

After the colour detection, different data are assigned to the workpiece. The vacuum gripper places the workpiece on the NFC reader for this purpose.



First, all data is deleted in the memory and the workpiece is marked as a raw product. The reader writes data relevant to the workpiece in the **NFC tag NTAG213** in the workpiece.

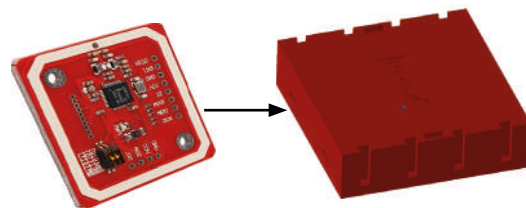

NFC reader

Important note: Each NFC tag has a unique ID. These do not have to be assigned, and also cannot be changed.

When one or more workpieces are ordered, they are moved to the output area after completing various work steps. Before this, additional production data for the individual workpiece can be saved in the available memory on the NFC tag.

Block diagram of the factory system display controller

The block diagram shows you how the individual factory components communicate with one another and how the system can be operated using the display of the TXT 0 (master).

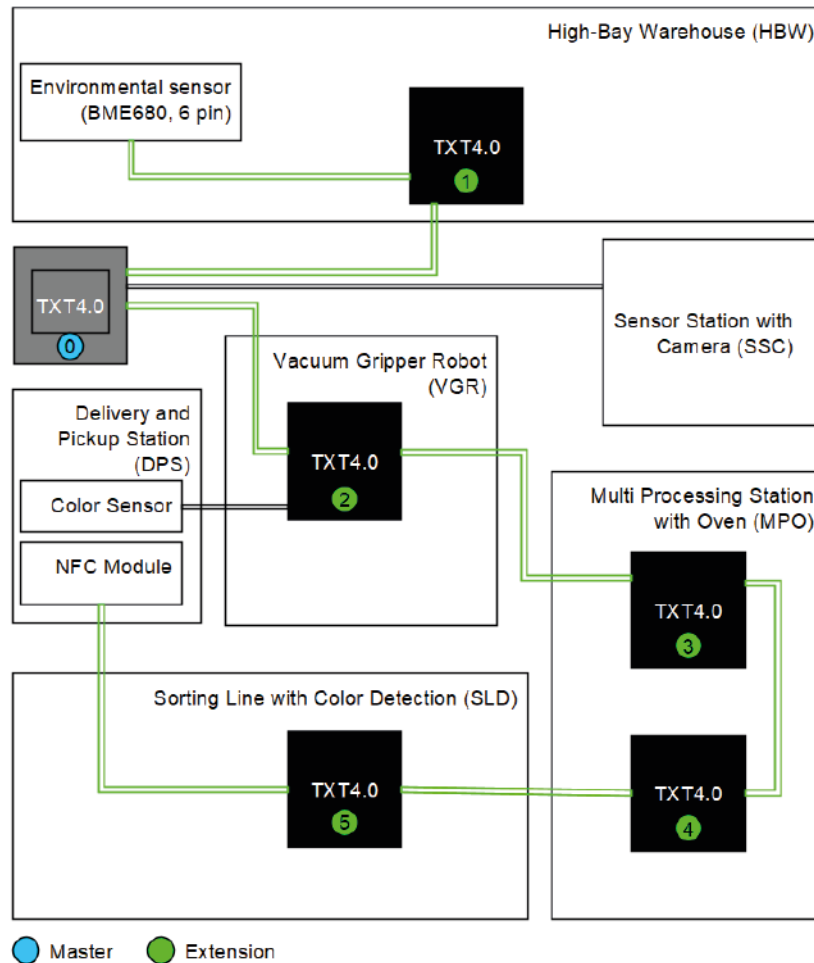

The TXT 4.0 Controller has a 6-pole extension plug EXT1 and EXT2 on the side of the housing.

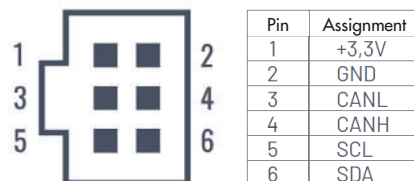

These plugs can be used to connect both I2C bus slaves as well as other TXT 4.0 Controllers as extensions. The components are connected using ribbon cables as shown in the figure. This allows the TXT 4.0 master to access and control all components.

The most important functions of the Factory can be operated fully offline using the TXT 4.0 display (graphic interface, GUI) of the "FactoryMain" program. The main program for the Training Factory 4.0 9V V.2 is created using the ROBO Pro Coding app, and the source text for the program can be downloaded freely and modified if desired. Upon delivery of the factory, the current version of the "FactoryMain" program is copied to the TXT 4.0 Controller.

If new versions are available, the example program "FactoryMain" can be imported directly to ROBO Pro Coding by the fischertechnik GitLab and then copied to the TXT 4.0 Controller using the ROBO Pro Coding app.

Explanation of elements in the GUI:

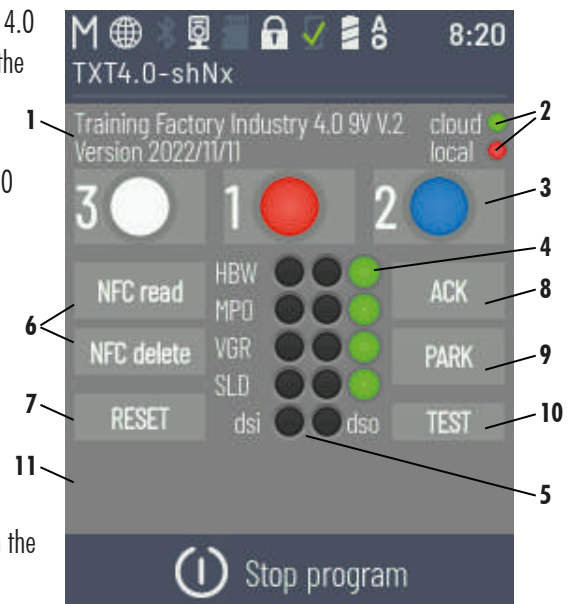

1 - The name and version of the ROBO Pro Coding program are displayed at the top in the 1st and 2nd lines

2 - The "cloud" and "local" indicator signals whether the Factory is connected to the fischertechnik Cloud with Node-RED dashboard

3 - The three coloured circles show the number of raw workpieces of each colour that are currently stored. If the raw workpiece in the corresponding colour is currently available, an order can be triggered for the desired colour by pressing the relevant workpiece.

4 - The 3-coloured indicators for HBW, MPO, VGR and SLD show the statuses of the stations (green: waiting status, yellow: processing, red: error)

5 - dsi and dso indicate the status of the storage and removal station

6 - "NFC read" and "NFC delete" can be used to read or delete a workpiece. To do so, the workpiece must first be placed on the NFC module and the factory must be in waiting status.

7 - The status of the high-bay warehouse is reset by pressing "RESET". All workpieces must be removed from the high-bay warehouse when this function is triggered. The status of the high-bay warehouse is saved on the TXT 0 in a file and loaded automatically when the program is restarted.

8 - The "ACK" button can be used to acknowledge an error

9 - The "PARK" button is used to move the Factory to parking position and end the program

10 - The "TEST" button is used to move all axes in sequence and then end the program. This function is useful to find mechanical or electrical errors in the individual axes.

11 - Status and error messages are shown in the bottom two lines

Block diagram of the local factory system

The block diagram shows you how the individual factory components communicate with one another and how the system is connected via a local network.

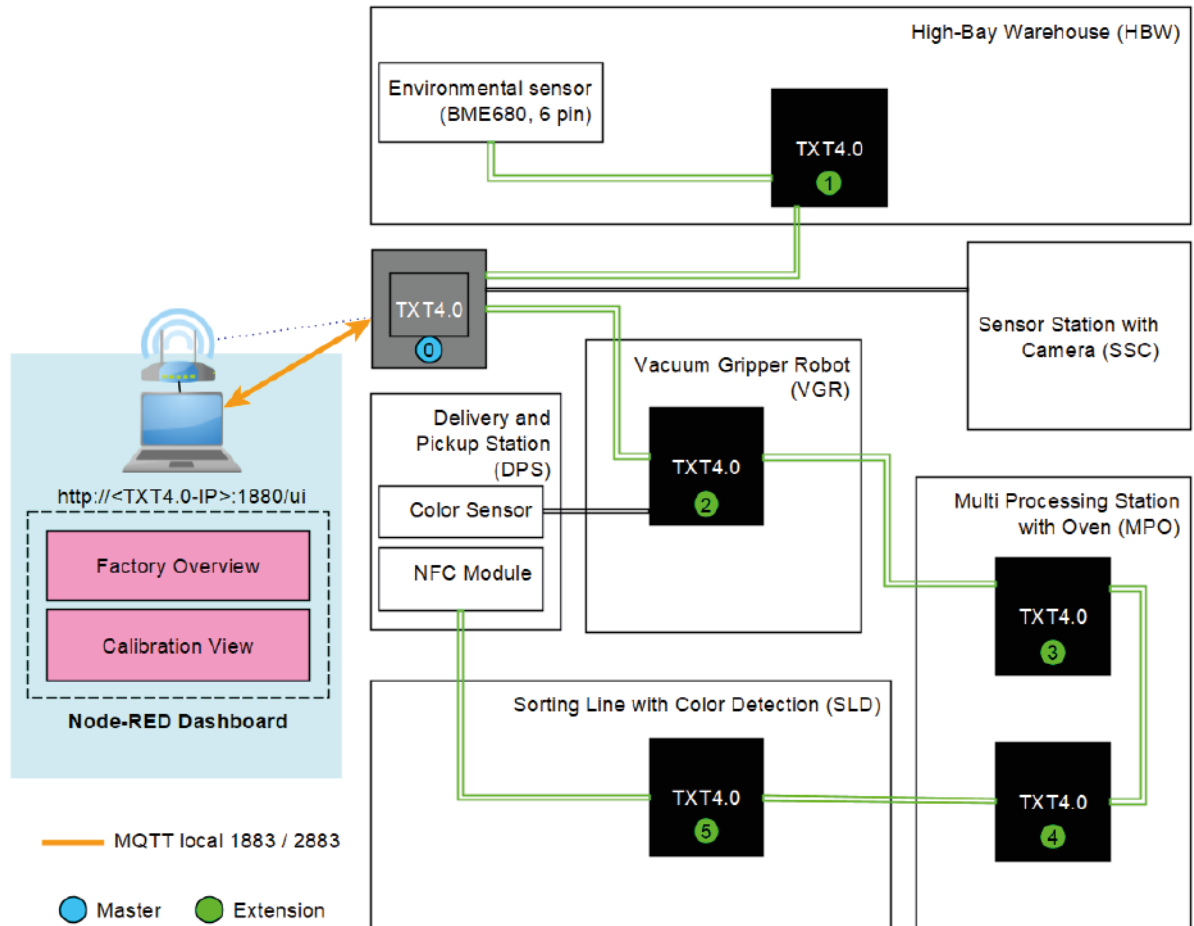

An additional device, such as a PC with monitor or a tablet (not included in the scope of delivery) can be used to access the local dashboard running on the TXT 4.0 Controller using a web browser (we recommend Chrome or Microsoft Edge). To do so, the TXT 4.0 Controller and the device must first be connected using a router in the same local network. The MQTT protocol is used for communication with the local dashboard.

MQTT stands for **M**essage **Q**ueuing **T**elemetry **T**ransport. MQTT is an open message protocol for machine-to-machine (M2M) communication. It allows for the transfer of telemetry data between the individual devices in the form of messages.

fischertechnik Node-Red Dashboard for the Training Factory

The fischertechnik Node-Red Dashboard is designed as a local HMI (human machine interface) operating interface in the local network. It can simply be started in a web browser (recommended: Chrome or Microsoft Edge) or by entering:

z.B. 192.168.0.100:1880/ui
 (IP address of the TXT 4.0 Controller: Port 1880 / ui as the name of the application)

Note: The TXT 4.0 Controller must first be connected with the WiFi router as described in the operating manual for the TXT 4.0 Controller. The device on which the web browser is accessed using the Node-RED Dashboard must be connected to the same WiFi router as well, and must be in the same local network.

The current IP address of the TXT 4.0 Controller, e.g. 192.168.0.100, can be read off directly on the display of the Controller under

Info -> WLAN -> IP

If no IP address is displayed, the TXT 4.0 Controller is not connected to WiFi.



When the “FactoryMain” program is started on the Training Factory, the following views are available:

Factory Main

The camera image and workpieces stored in the high-bay warehouse are displayed in this menu.

The user can click in the “**Factory Control**” window to reset the configuration of the high-bay warehouse.

The user can click to acknowledge errors in the Training Factory 4.0.

The user can click to move the Training Factory into parking position.

The camera can be moved in the “Camera Control” window.

Commands can be sent to the NFC module in the “NFC Control” window.

An order for a workpiece can be triggered in the “Order” window.

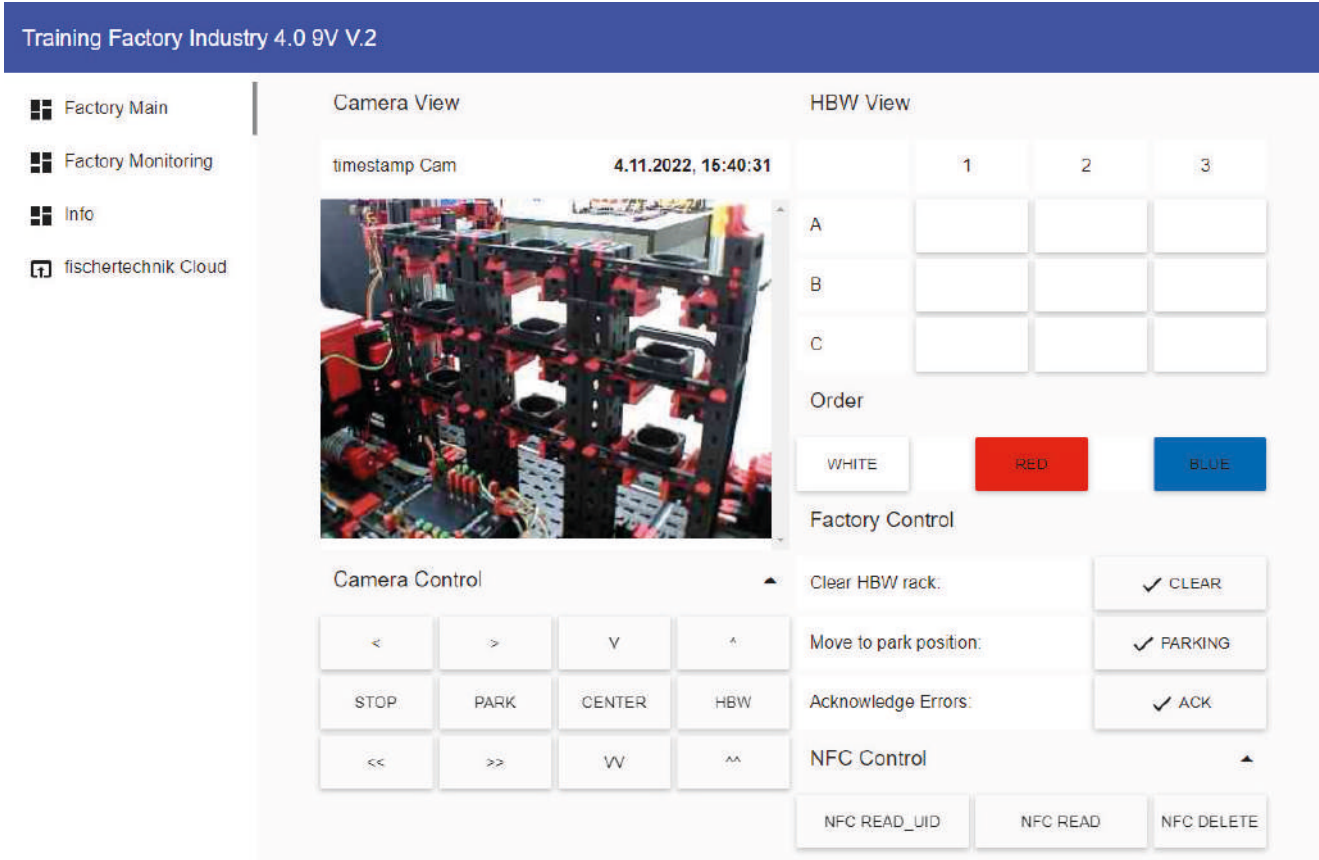

Factory Monitoring

The sensor values can be monitored in this view.

Training Factory Industry 4.0 9V V.2

- Factory Main
- Factory Monitoring**
- Info
- fischertechnik Cloud

Monitoring - Sensors

timestamp BME680	4.11.2022, 15:41:17
temperature	28.1 °C
humidity	23.9 % r.H.
pressure	931.5 hPa
air quality	-1
air quality accuracy	2
timestamp LDR	4.11.2022, 15:41:17
brightness	98 %

Monitoring - Brightness

Brightness Graph



Info

The software versions are displayed here.

Training Factory Industry 4.0 9V V.2

- Factory Main
- Factory Monitoring
- Info**
- fischertechnik Cloud

Software

Node-RED Flow	Version 2022/11/04
FactoryMain	Version 2022/11/04

Block diagram of the factory system with internet connection

The block diagram shows you how the individual factory components communicate with one another and how the system can be operated using the the fischertechnik Cloud (www.fischertechnik-cloud.com).

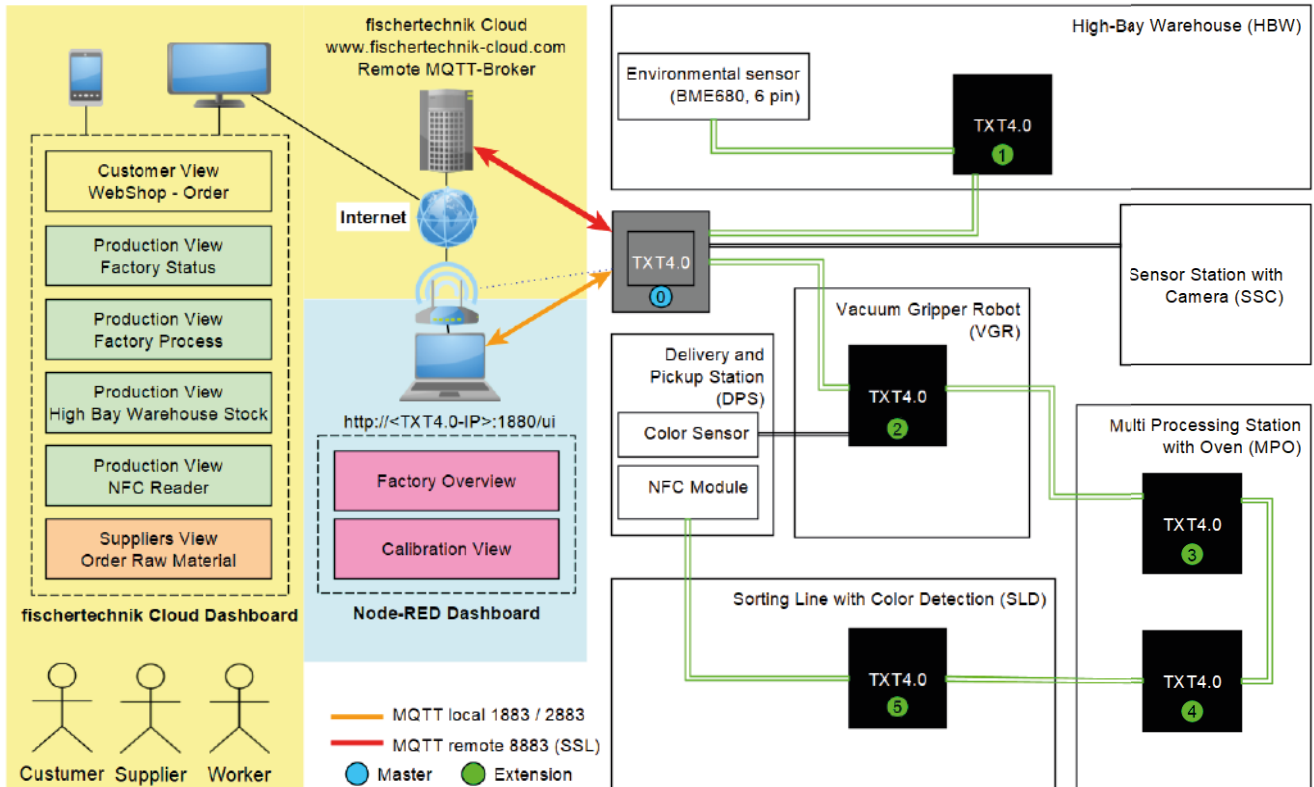

The block diagram shows you the individual displays within the "Training Factory Industry 4.0" dashboard.

Training Factory dashboard in the fischertechnik Cloud

The dashboard in the fischertechnik Cloud consists of different views.

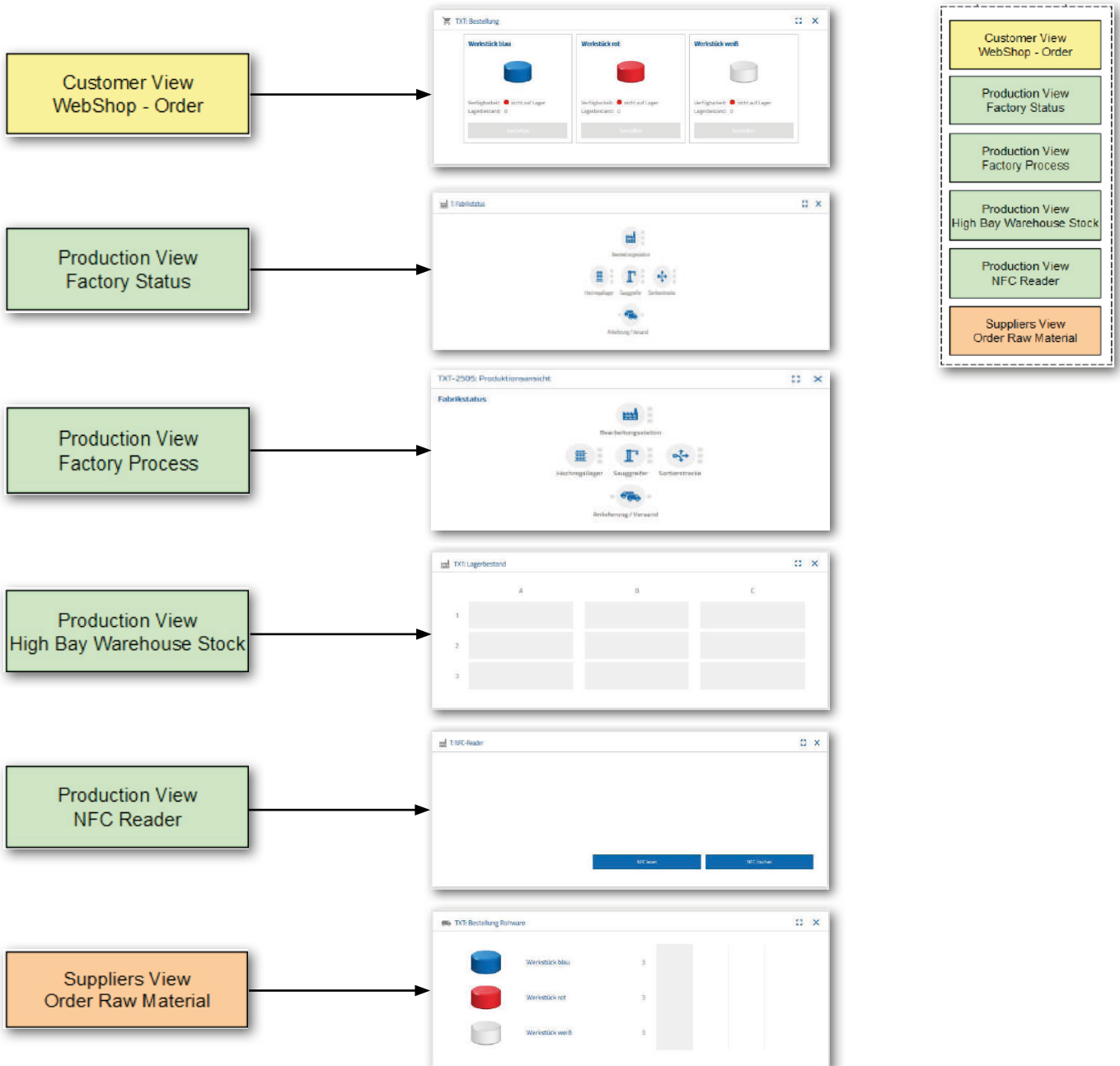

The dashboard can be accessed and operated via mobile devices such as tablets and smartphones as well as laptops and PCs. It enables factory scenarios to be displayed from three different perspectives:

Customer view

Supplier view

Production view

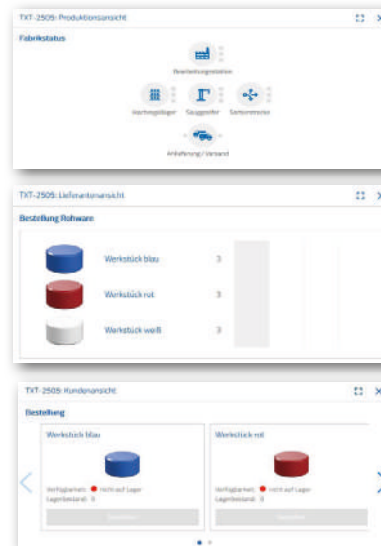

User registration

You have to register before you can work with the dashboard. To do so, access the page

www.fischertechnik-cloud.com

. We recommend using the "firefox" or "Google Chrome" browsers.

Enter the address. The following screen appears.

Important note: If the page does not load, it must be reloaded using the key combination "CTRL + F5". This is a general browser problem.

Bei fischertechnik anmelden

Nutzername oder E-Mail-Adresse

Passwort

Anmelden

Neu bei fischertechnik? Jetzt registrieren ...

[Passwort vergessen?](#)

In order to register for the first time, select:

“New at fischertechnik? Register now...”

Complete all fields and accept the data privacy guidelines. Click the square beside “I am not a robot” and answer the questions.

Confirm your registration with the button:



After registering, you can always log in using your user name and password. Then your dashboard will be started. After you complete the next point, the dashboard is filled with data.

Cloud connection

Only one TXT 4.0 Controller is connected to the cloud by the Training Factory 4.0, the TXT 0.

The following settings must be completed on this TXT 4.0 in order to connect to the fischertechnik Cloud:

Connect the TXT 4.0 Controller to the fischertechnik cloud using “Settings - fischertechnik Cloud”.

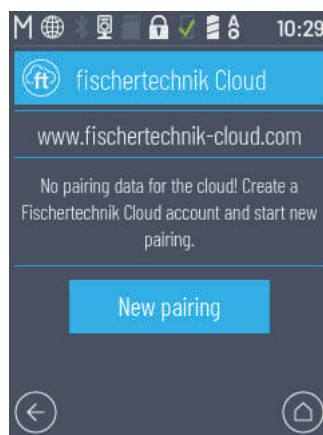
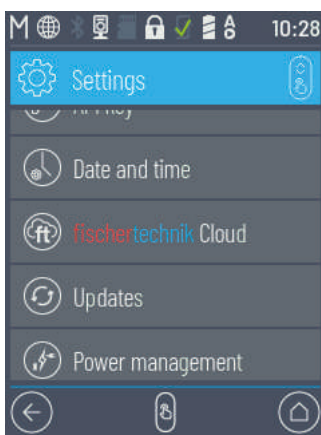



If the TXT 4.0 Controller can connect to the Cloud, a QR code and coupling code will appear. You now have 30 minutes to add the TXT 4.0 Controller to your account in the cloud. After this time expires, you must restart the coupling process.

You can scan the QR code, for instance using the “Quick Scan” app, and you will be sent automatically to the fischertechnik Cloud.

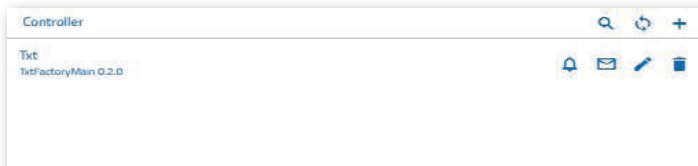

Alternatively, you can go to “Settings - Add Controller” on the fischertechnik Cloud page and enter the coupling code there manually.

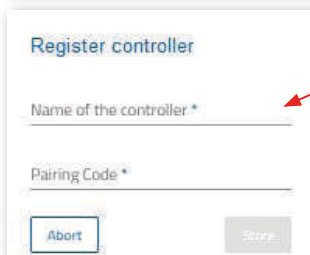

Enter any name for the TXT 4.0 Controller here, such as its ID “TXT-7133”.

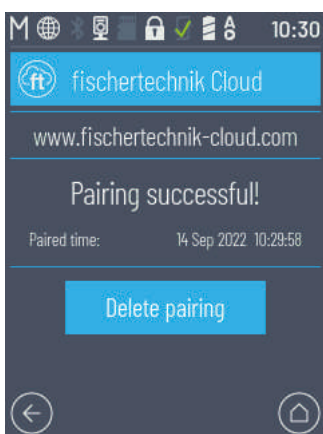
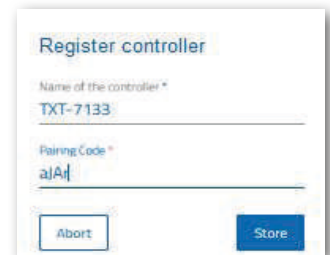

Now the TXT 4.0 Controller is connected to the cloud.

Under

“File - Cloud”,

download the **FactoryMain** application to the TXT Controller.

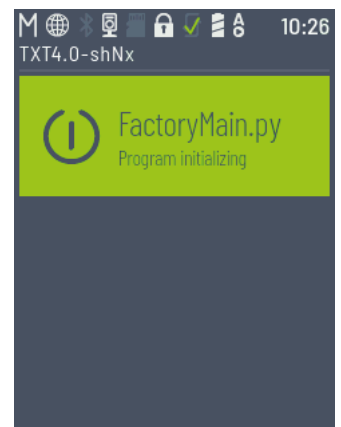

Once the connection to the Cloud is complete, start the applications on the TXT 4.0 Controller.

Factory dashboard

This appears with the following screen:

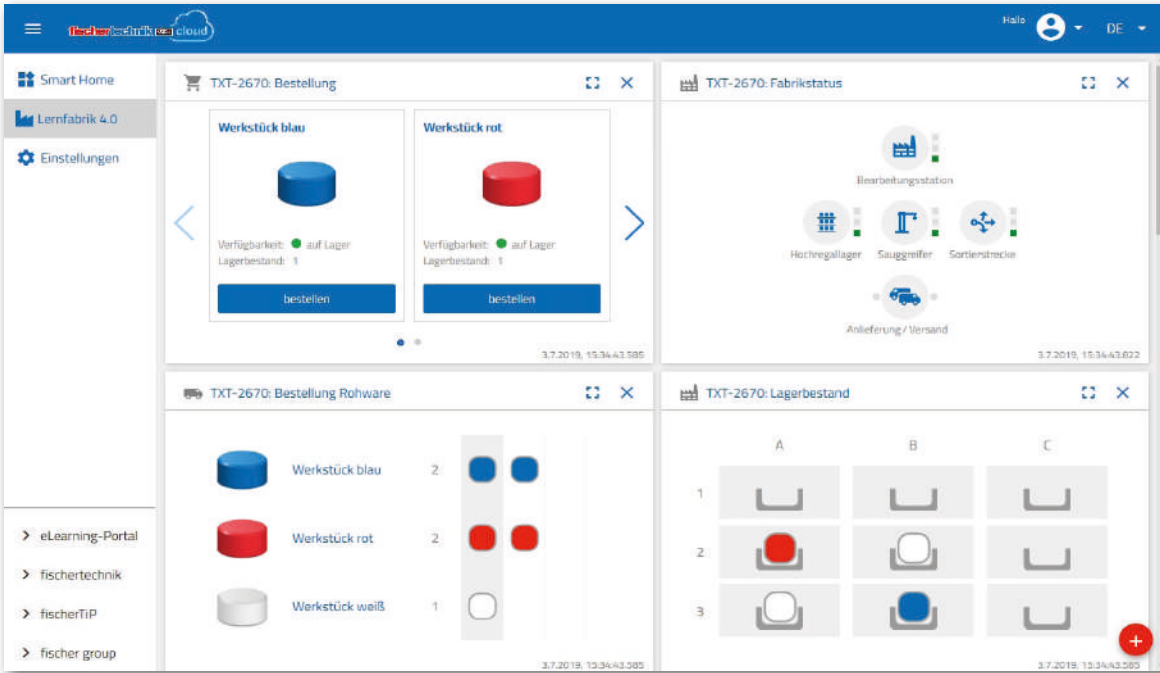

You can change the order of the individual screens to meet your needs.

This button can be used to expand or collapse the main menu for the cloud.

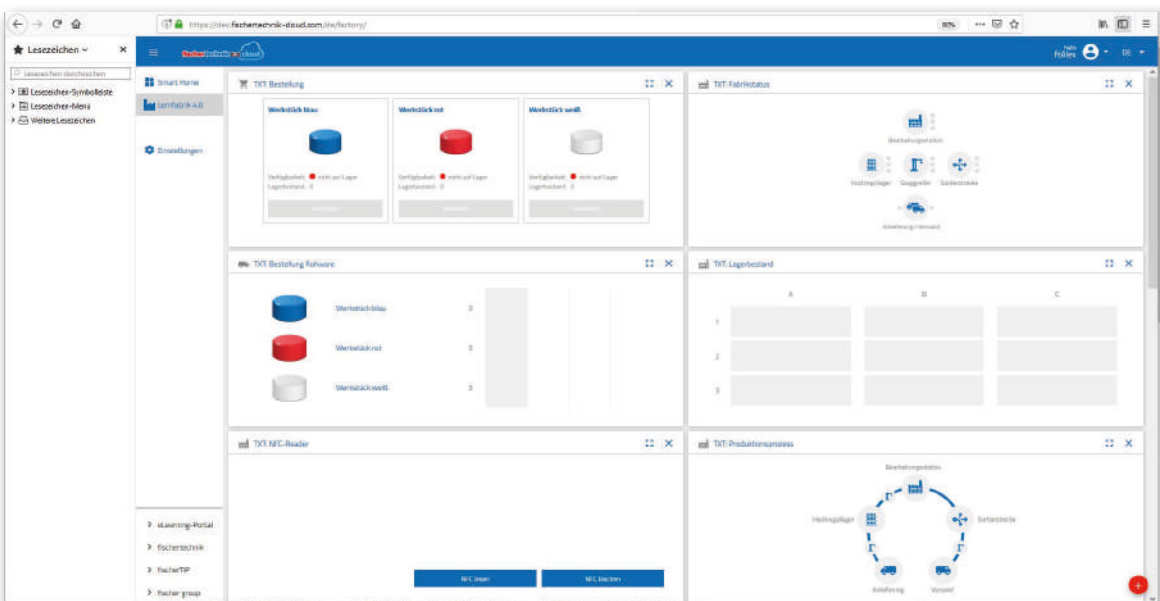

Overview of the individual windows and their functions:

Ordering raw goods

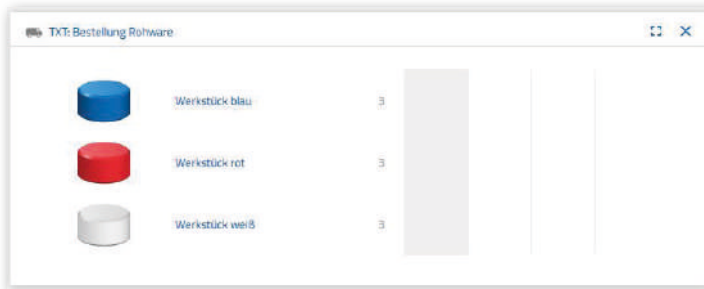

The "Ordering raw goods" view: The display shows the raw goods that are missing and need to be reordered.

Inventory



In the Inventory window, you can see how many raw goods were stored in the high rack. If goods are removed, the numbers and colours for the inventory are changed.

Purchase order

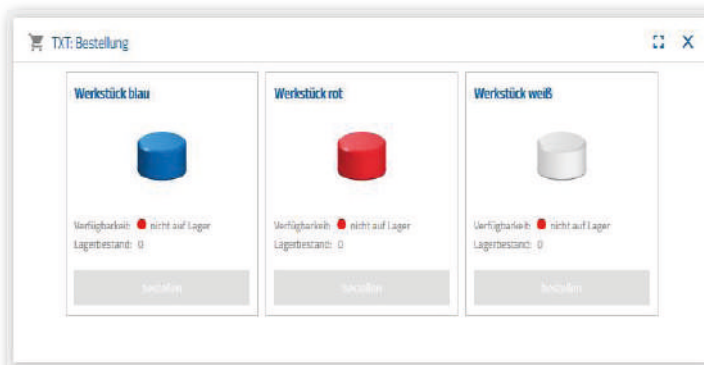

This window shows how many raw goods (blue, red, white) are available in the warehouse. If a red workpiece is placed on the shelf, for instance, the colour display and inventory value change.

Factory status

The current working status of the overall factory is displayed in the "Factory status" window. For instance, if the vacuum gripper is currently working, this is visually displayed by the icon being highlighted in blue.



Production status

This window shows the production process, highlighted in blue, after you have ordered a workpiece. This allows you to track where the workpiece currently is in the factory system.



NFC reader

The current status of the NFC reader is always displayed in this window.

However, you can also place a workpiece on the reader and read out the data in the NFC tag.

"Delete" can be used to delete the contents of the NFC tag.

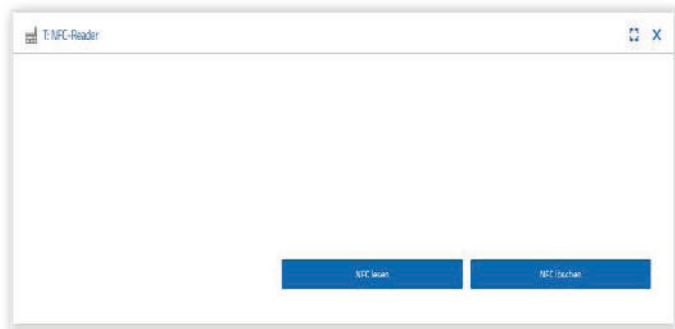

Camera dashboard

Camera

The camera detail for your factory system is displayed in the “Camera” screen.

This is a live image of the factory.

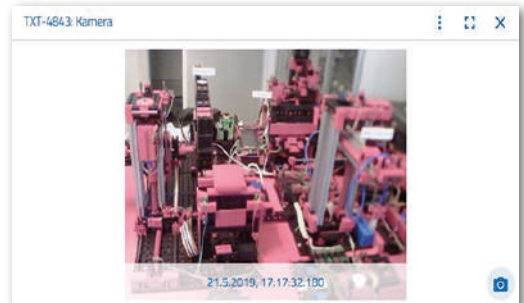

Camera controller

This screen allows you to control your camera live. This provides you with an overview of the entire factory system.

You control the camera using the virtual joystick. The red point shows you the centre of the camera. You can use the “Increment” button to determine how many degrees the camera should turn when you click the arrow. The two red buttons can be used to centre or stop the camera.



Create snapshot

You can use the “Create snapshot for the current image” to save the current image in the “Gallery” screen.



Gallery

All images you have created are saved to the “Gallery” window. You can browse through the gallery using the arrow buttons. The current image is showed zoomed in. You can remove this image from the gallery using the “Delete” command.

If you would like to save the image for further use, use the “Download” command. Enter a storage location in the context menu which opens.

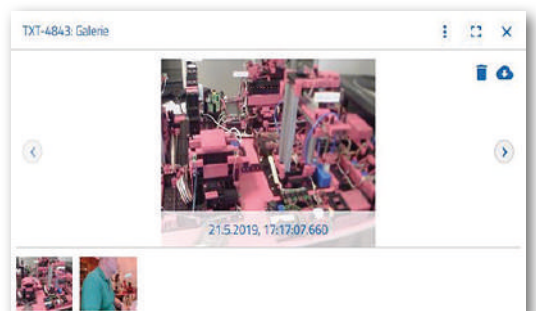

Environmental station dashboard

In addition to the camera function, you can view and process the information from the environmental sensor.

Current air quality

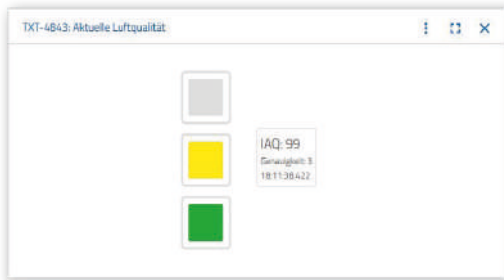

The “Current air quality” window shows you the air quality value visually using three rectangles. The displays are switched on depending on the quality of the measured air. Green stands for very good, green and yellow for good, yellow for satisfactory, green and red for sufficient and red for poor.

You can use the “More” button (applies for all environmental sensor windows) to choose between

the “Graph”, “Single value” and “Download” views.

If you choose “Graph”, you will see a graphic representation of the measured values. You can use the scroll bar to scroll through all recorded data.

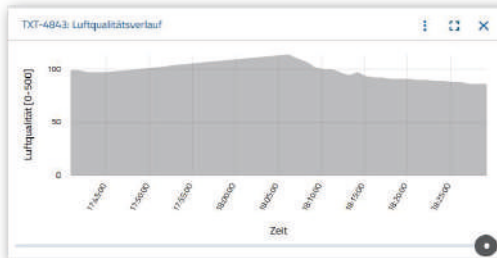

If you choose “Download”, the data is downloaded as a .csv file, and can be displayed using OpenOffice Calc or Excel, for instance. You can then further process the data.

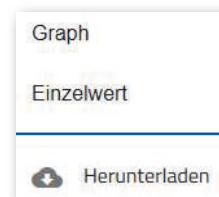

date	time	indoor	air	quality:iaq	accuracy
7	5:2019:17:07:30			63,0	
7	5:2019:17:08:30			61,0	
7	5:2019:17:12:26			63,0	
7	5:2019:17:13:40			63,0	
7	5:2019:17:14:40			60,0	
7	5:2019:17:17:05			63,0	
7	5:2019:17:18:05			76,0	
7	5:2019:17:19:05			110,0	
7	5:2019:17:20:38			195,0	
7	5:2019:17:21:38			267,0	
7	5:2019:17:22:38			288,2	

Current brightness

The “Current brightness” window shows you a brightness value in %, as well as the time at which this measured value was taken. The fluctuations in brightness are also shown.

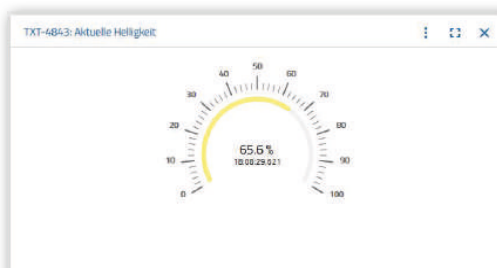

Current air pressure

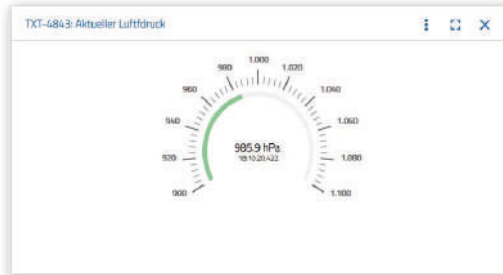

The “Current air pressure” window shows you the air pressure in hPa (Hecto-Pascal), as well as the time at which this measured value was taken.

Current humidity

The “Current humidity” window shows you the relative humidity value in %.

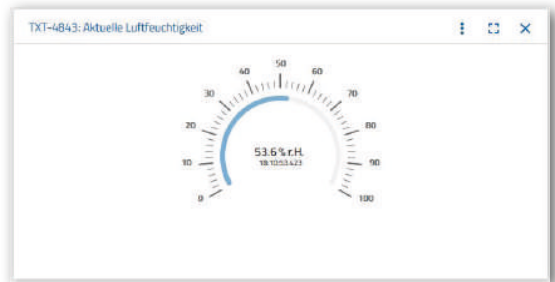

Current temperature

The current temperature (ambient temperature) of the measurement sensor is displayed in °C in the “Current temperature” window.

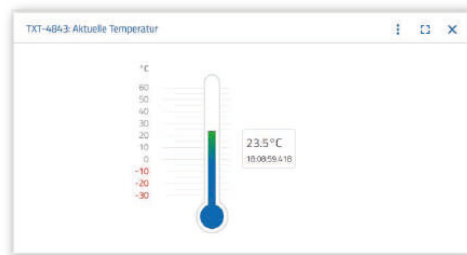

Other buttons

You can use the “Add window” button to add a window that is not currently visible. When you activate the button, a context menu appears from which you can show a dashboard window.

You can use this button to close the current window.

You can use this button to zoom the current window out to full screen mode.

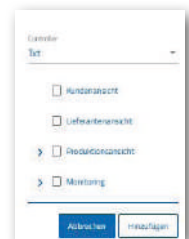

You can use this button to show or hide the left status bar.



The button shows that you have logged in under your profile. Click the arrow to display a context menu. You can select "Profile" or "Log out" here. If you select "Profile", another context menu appears where you can change your profile settings. Use "Log out" to log out of the fischertechnik Cloud.

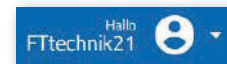
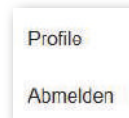

If you activate the arrow beside "DE", a context menu appears to select the language.



There are three selections in the status bar that you can activate by clicking on them. You can use the first two buttons to choose whether you want to work with the dashboard of the factory simulation, or only with the dashboard of the environmental station.

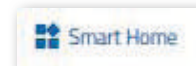

If you activate the "Settings" button, a context menu appears where you can view and change different parameters for your TXT Controller.

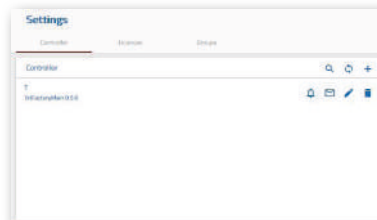

Factory operation tasks

The different tasks will teach you how to operate the factory and the dashboard.

Task 1

Before raw goods can be stored in the high-bay warehouse, the compartments must be filled with the enclosed empty containers. This is the first task you must complete as a warehouse clerk.

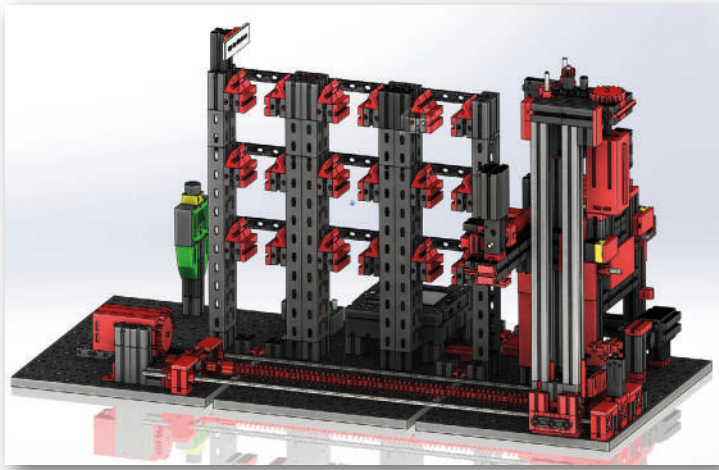

9 x

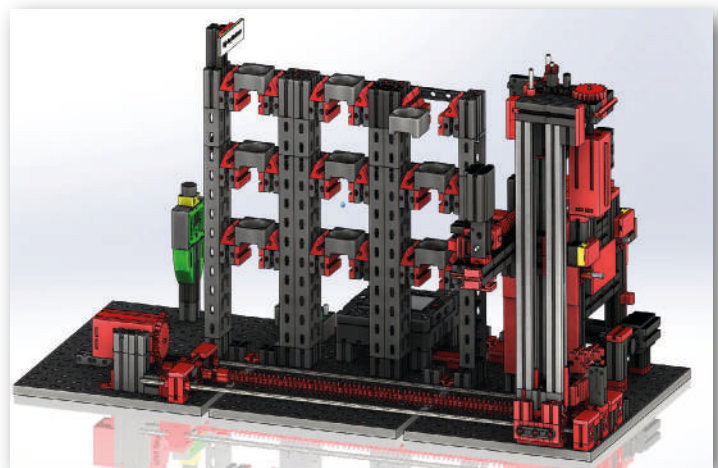
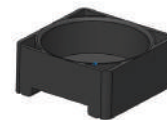

Your dashboard looks like this:



Purchase order

Blue, red, white not available, inventory 0



Ordering raw goods

No order entered

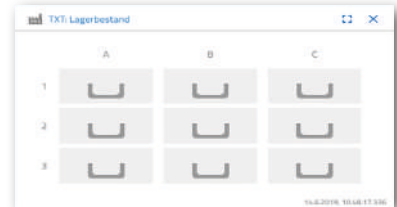

Inventory

Inventory empty, since no raw goods have been stored

Important note: If this is not the case, you can use the enclosed key fob or card (with integrated NFC tag) to reset the dashboard window to its default settings.



Task 2

Order raw goods that are to be stored in the high-bay warehouse as inventory. To do so, place the raw goods manually into the input station.

First, only store a white rock as a workpiece.



Place a white rock in the material input. The workpiece (raw goods) interrupts the light barrier. This process is detected as a "delivery" and shown in the "Production process" dashboard window with the "Delivery" icon highlighted in green.

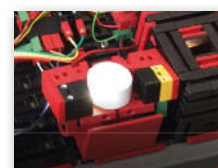

Then the vacuum gripper moves to the storage position, picks up the raw good and moves it first to the colour sensor, and then to the NFC reader.

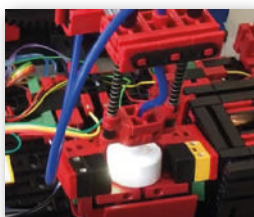

The process is shown in the dashboard window as follows:

Delivery and vacuum gripper are active and are shown in green.



All data on the NFC tag for the raw good (already written) is deleted.

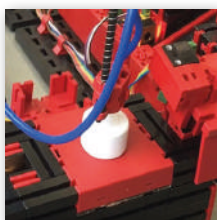

The colour of the raw good is detected by the colour sensor. The data is available to the NFC reader for further processing.

Before the raw good is stored, the determined colour data and other information such as delivery data and quality controlling data are written to the NFC tag using the NFC reader.

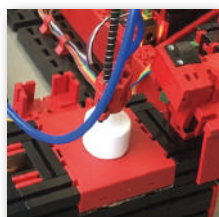

Since both factory modules (delivery and vacuum gripper) are still active, these are still shown as green in the "Production process" dashboard window.

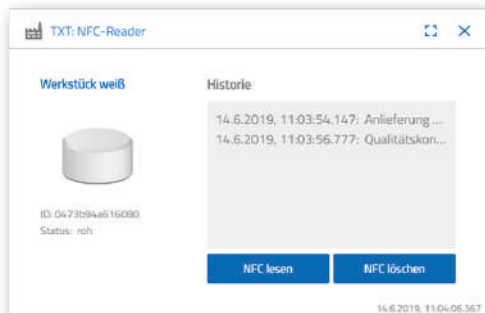

This data is displayed in the "NFC reader dashboard window."

What happens next?

The high-bay warehouse provides an empty container to hold the raw goods. To do so, the gripper arm moves into position for an empty container, picks it up using its peel and places it on the input / output device.

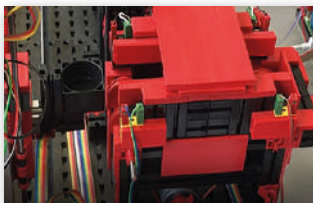

A conveyor device is used to move the container to the input position.

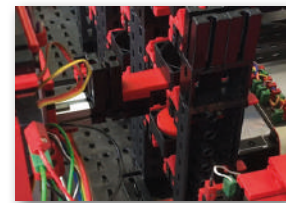

The vacuum gripper arm turns into the discharge position, moves down and places the raw goods in the provided container.



The container with the raw goods is transported in the input/output device to the high-bay warehouse gripper arm pick-up position. The container is picked up here, moved to the storage position in the high-bay warehouse, and stored there.

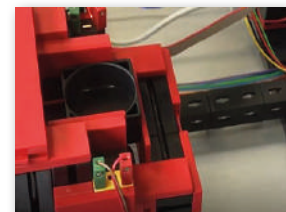

The next steps in the storage process are displayed to you in the "Production process" dashboard window. The icons for all active factory modules are illuminated green when the factory modules are in action.

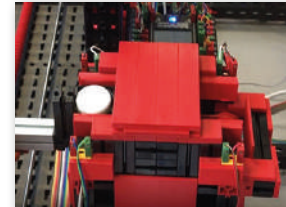

Look at the following dashboard window - TXT: Ordering raw goods, TXT: Inventory and TXT: Purchase order.

TXT: Ordering raw goods

There are 3 workpieces for each colour available to you as warehouse clerk to order raw goods.

After you have stored a white stone in task 2, the maximum number of white stones is reduced by 1 in the dashboard window "TXT: ordering raw goods". This means you have 2 more workpieces available to store.

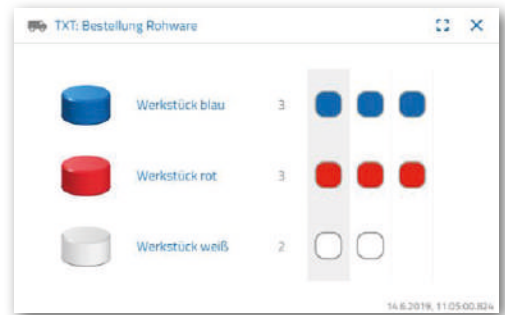

TXT: Inventory

Now, a white stone is displayed to you in the warehouse system in the dashboard window "TXT: inventory". This means that you can order and have this workpiece processed as the customer.

TXT: Purchase order

Now, a white stone is displayed to you as being in stock and available for ordering in the dashboard window "TXT: Purchase order".

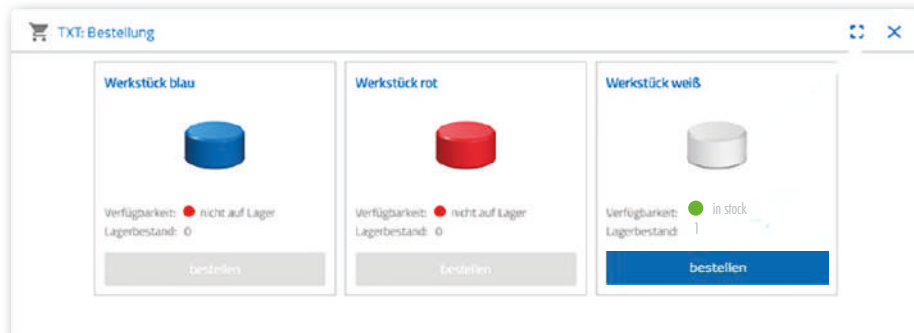
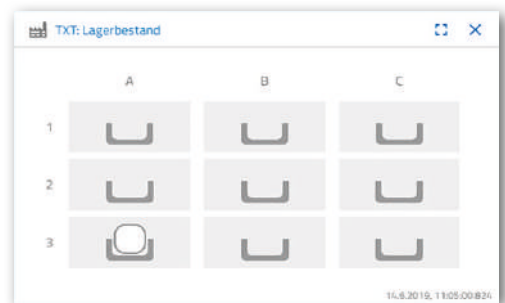

Task 3

Order the raw goods to be stored as inventory in the high-bay warehouse. To do so, place the raw goods manually into the input station.

Now, store a blue rock as the workpiece.

As described in task 2, place a blue stone in the high-bay warehouse. Once the storage tasks have been completed, the results are displayed in the dashboard.

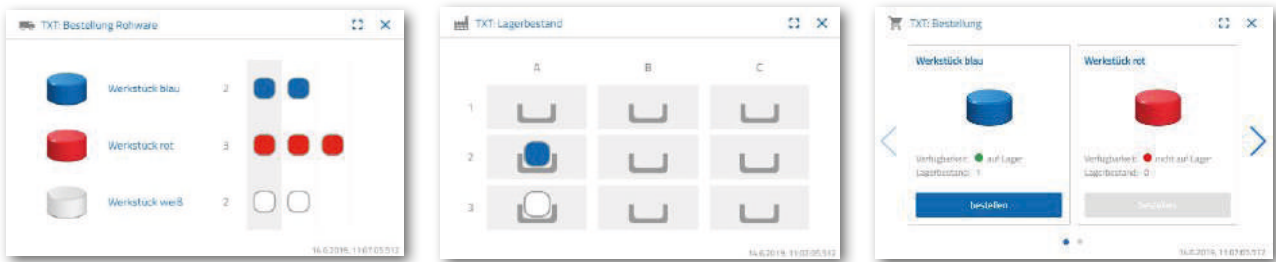

Task 4

Store additional raw goods in the high-bay warehouse as inventory. You need two white and one red workpieces.

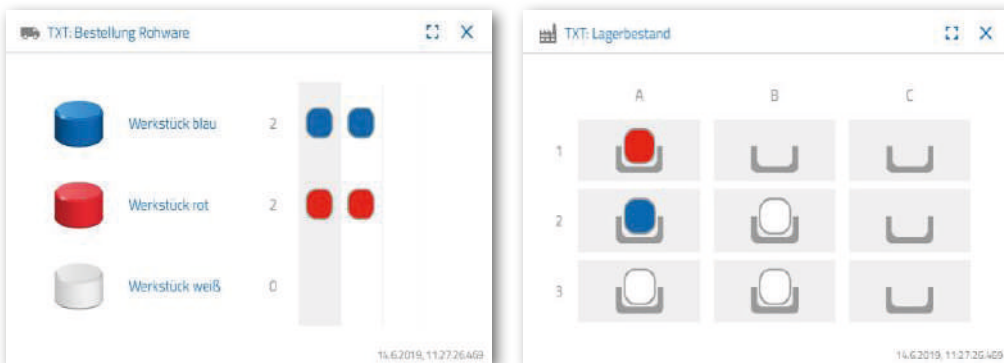

Task 5

Imagine you were a customer who wanted to order a white workpiece, for instance. Order a white workpiece.



To do so, activate the blue “Order” button in the “TXT: Order dashboard window.

What happens in the factory system: The transport arm of the high-bay warehouse moves to the storage position for a “white workpiece”.

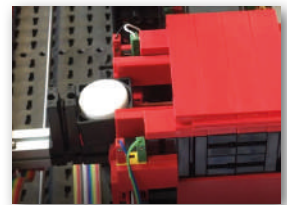

Pick it up and place it in the input/output station of the high-bay warehouse. There, it is moved to the pick-up position of the vacuum gripper.



The vacuum gripper picks up the workpiece at the pick-up position and places it on the peel of the furnace.

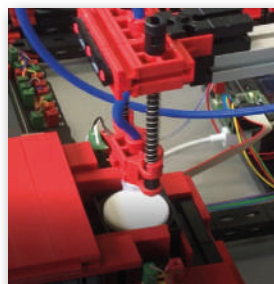

The workpiece is pushed in, burned, and moved back out of the furnace. The provided transport sled with vacuum suction cup transports it to the “Milling” processing machine.

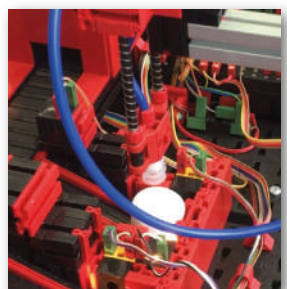
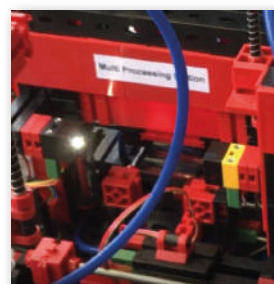

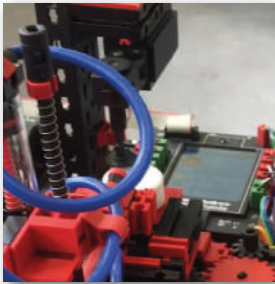

After the milling process is complete, the workpiece will be turned horizontally by 90 degrees and pushed onto a conveyor belt using pneumatic equipment.

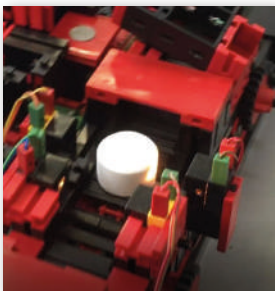
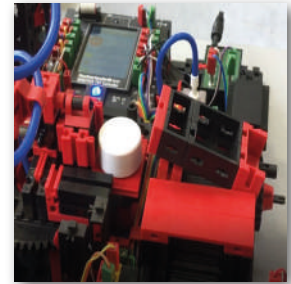

The workpiece goes through colour detection on the way to the sorting device.

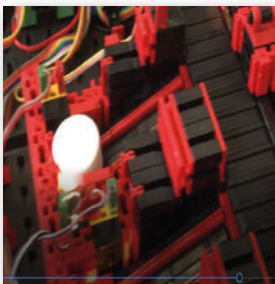
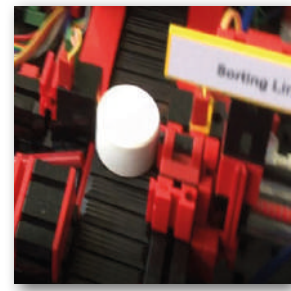

Depending on the detected colour, the workpiece is pushed pneumatically from the conveyor belt in front of a material slide. The workpiece is in a pick-up area and can be transported from here using the vacuum gripper.

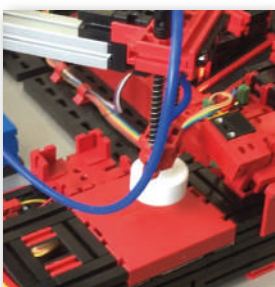
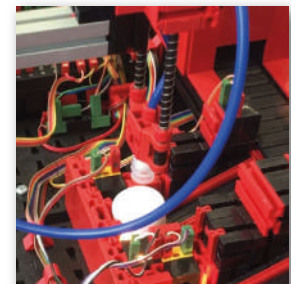

The gripper places the workpiece on the NFC reader for final labelling. There, it is labelled with relevant workpiece data such as the order date, manufacturing or delivery date.

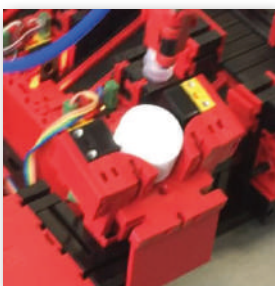

Then the workpiece is placed in the output compartment of the input / output station.

You can also track the work steps in the dashboard.



Raw goods are removed from the high-bay warehouse and fed into the processing sequence.

Raw goods are processed in the multi-processing station (furnace, milling machine).



The processed workpiece is sorted by colour and labelled with relevant data using the NFC reader.

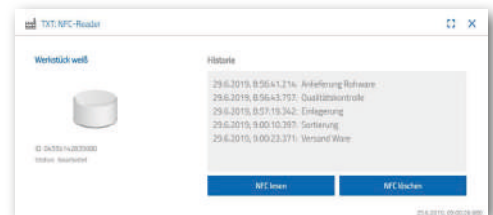

The workpiece is ready for delivery and can be removed from the system.



Task 6

A white stone has accidentally fallen out of the high-bay warehouse, and you want to know which data was written on the NFC tag.

The system must be in idle state to do so. Place the workpiece on the NFC reader and activate the "Read NFC" button in the "TXT: NFC reader" dashboard window.

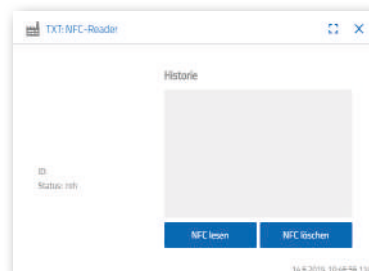

The NFC reader reads out the data and displays it in the dashboard window.

You can use the "Delete NFC" button to delete the data if needed.

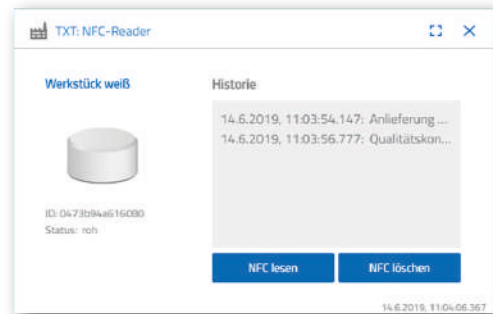

Task 7

Analyse data from your environmental station. To do so, first display the data in the graph area of the dashboard view. Save the data as a .csv file and use it in a spreadsheet program.

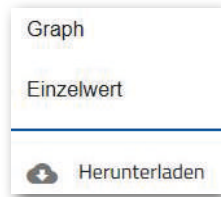

Determine the data for the brightness of your factory.

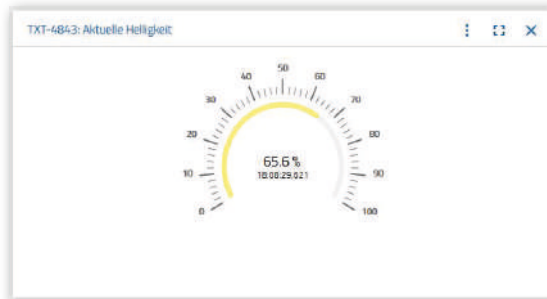

Determine the current temperature data for your factory and process it using a spreadsheet program.

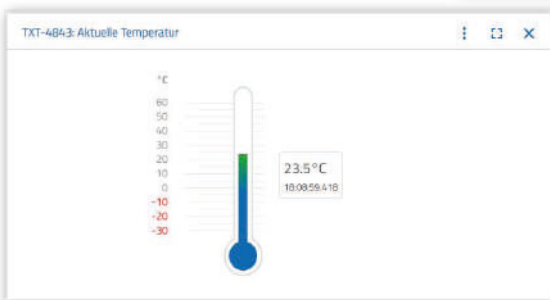

Determine the humidity values over a long period of time and display them graphically in the dashboard.

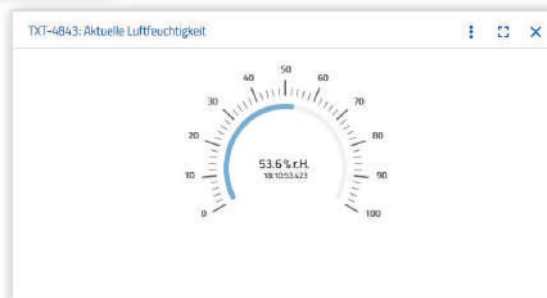

Task 8

Monitor your factory using the built-in camera. Move the camera over your factory and take 2 photos of the factory system. Save one image for documentation. Delete images you no longer need from the gallery.

To move the camera, use the dashboard window "TXT: Camera controller".

The buttons used in the task are explained on page 30.

Move the camera over your factory system. Move the vertical and horizontal axis of your camera using the "blue arrow buttons".

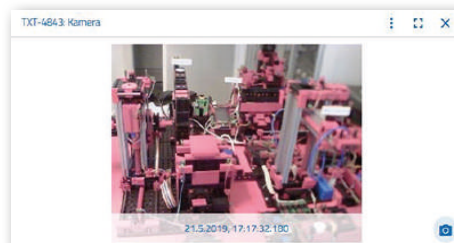
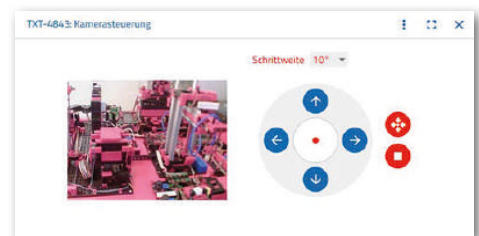

The section of the factory currently being photographed by the camera is also displayed to you in the dashboard window "Training Factory 4.0: Camera".

Choose the three images and save them in the dashboard window "Training Factory 4.0: Gallery". Use the "Create snapshot for the current screen" button to do so.



Choose 1 image from the gallery that you want to process in the image processing program. To do so, click the "Download" button. A context menu will appear where you can specify the storage location and file name.



Delete images you no longer need using the "Delete" button.

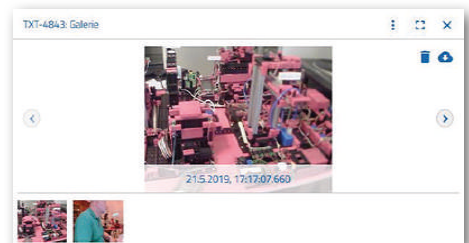

Component description

Before the individual factory modules are explained, we will first describe the most important components.

Actuators

Both encoder motors and fischertechnik-specific mini-motors are installed in the individual stations.

Encoder motor:

The encoder motors are permanently excited DC machines that can be used for incremental angular measurement with the help of Hall sensors. The encoder motors are operated with a rated voltage of 9 VDC, and have a maximum power of 1.2 W at a speed of 105 rpm. The current consumption at maximum performance is 386 mA. The ratio for the integrated gearing is 21.3:1. This means that the encoder generates three pulses per rotation of the motor shaft, or 63.9 pulses per rotation of the gear unit output shaft. Since only one pulse is registered, the encoder used can not determine the direction in which the motor is turning.

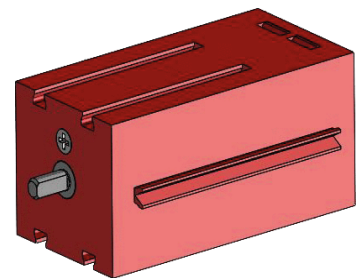

The encoder is connected to the TXT Controller using a three-wire cable; the red wire must be connected to a 9V output and the green wire must be connected to ground. The black cable transmits the signal (npn open collector output, max. 1kHz) and must be connected with a high speed input (C1-C4). If the encoder signal cannot be read out using a fischertechnik Controller, a pull-up resistor (4.7-10k Ω) must be used.

Mini-motor

If conveyor belts or processing machines are used in individual stations, these are driven by a mini-motor. This compact motor is a permanently excited DC machine that can be used along with an attachable U-gear. The rated voltage of the motor is 9 V and the maximum current consumption is 650 mA. This results in a maximum torque of 4.8 mNm and an idling speed of 9500 rpm. The U-gear has a ratio of 64.8:1 and a side output.

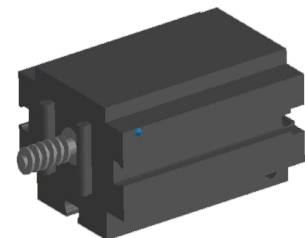

Compressor:

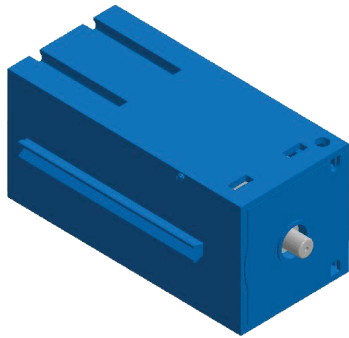

A membrane pump is used if a compressed air source is required for the stations.

This kind of membrane pump consists of two chambers that are separated by a membrane (cf. Image 1). A piston is back and forth in one of these two chambers by a cam, which reduces or increases the volume in the other chamber. If the piston moves to the right, the membrane is pulled back, which suctions air into the second chamber via the inlet valve. If the piston moves to the left, the membrane presses the air out of the pump head via the outlet valve. The compressor used here is operated with a rated voltage of 9 VDC and generates excess pressure of 0.7 bar. The maximum current consumption for the compressor is 200 mA.

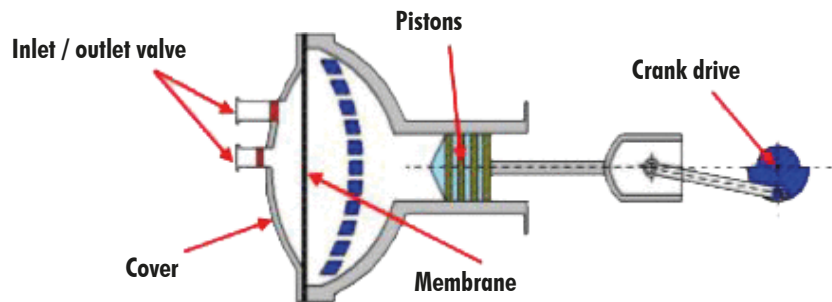
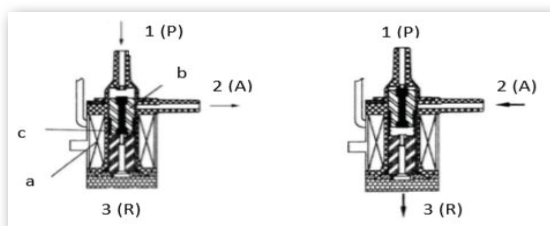
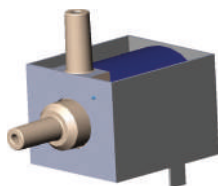

Figure 1

3/2-way solenoid valve:

3/2-way solenoid valves are used to control the pneumatic cylinders. These switching valves have three connections and two switching states. The switching processes are carried out by a coil (a) that works against a spring (c). When voltage is applied to the coil, the core (b) (which is mounted in a movable manner) of the coil is moved against the spring due to the Lorentz force, opening the valve. In this case, opening is understood as the compressed air connection (1, old designation: P) is connected to the cylinder connection (2, previously A). If the voltage drops, the spring presses the core back again and closes the valve. In this position, the cylinder connection (2, previously A) is connected with the ventilation (3, previously R). The image shows a schematic diagram of the 3/2-way solenoid valve.



Pneumatic cylinders:

A total of 5 single-action cylinders with springs are installed in the factory system. These are controlled using the 3/2-way solenoid valves. In pneumatic cylinders, a piston divides the volume of the cylinder into two chambers. A pressure differential between these two chambers results in a force acting on the pistons and causing them to move. The movement corresponds to a change in the volumes of both chambers. Installing a return spring eliminates the need for a 2nd air connection with 3/2-way valve. When the 3/2-way solenoid valve is opened, the air generated in the compressor flows to connection 1 of the cylinder and presses the piston forward against the spring force. This causes the piston rod to move forward and out. If the solenoid valve closes the air feed, the spring pushes the piston back into its initial position.

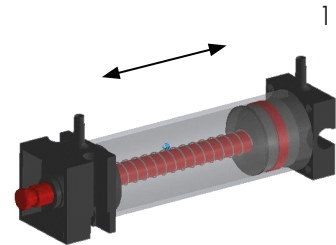

Vacuum suction cup:

The suction function of the vacuum suction cup is delivered via two pneumatic cylinders that are activated with the help of a 3/2-way solenoid valve. Two cylinders are coupled mechanically in order to generate vacuum pressure in the vacuum gripper, a pressure that is lower than the ambient pressure. When one cylinder is exposed to over-pressure, both piston rods extend, increasing the volume in the chamber closed by the suction cup. This increase in volume is associated with a drop in pressure in this chamber.

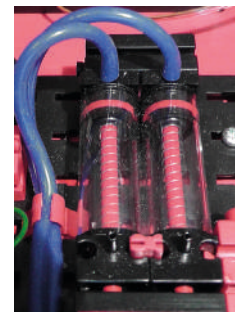

Mini buttons:

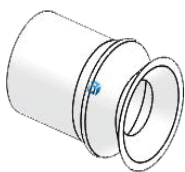

Mini buttons are used as reference switches. They are used for position determination in a point-to-point movement, such as by the rotary table. The mini button used for this purpose is equipped with a changeover contact and can be used as both a normally open and normally closed contact. When the button is activated, there is a conductive connection between contact 1 and contact 3, while the connection between contact 1 and contact 2 is disconnected. The image shows a schematic wiring diagram of the mini plug.

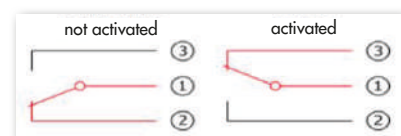

LED

An LED is an electronic component which converts electrical energy into light. The abbreviation LED stems from the English "Light Emitting Diode".

There are 2 different LEDs built into the factory system.

LED for generating light in a light barrier

The light frequency of the LED used for this purpose controls a photoresistor.

The module can be identified because "+" and "L" are printed on it. Another feature is the glass body. This combines the radiant light beams so that they hit the phototransistor in parallel, rather than scattered.



LED as a light

A simple LED is used for this purpose. The module can be identified because "+" and "W" (white) are printed on it. Another feature is the light cylinder, which appears milky.



Phototransistor Sensors

The phototransistor is an electronic component that reacts to incident light.

Phototransistors usually have just two connections - the collector and the emitter. The base is replaced by the incident light. When the light from the LED hits the phototransistor, it switches the current flow. This behaviour can be analysed using a program.

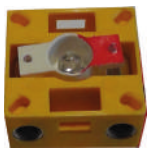

Photoresistor

A photoresistor is an electronic component, the electrical resistance of which changes when light hits it. This is also called an LDR in many descriptions. The abbreviation stands for "Light Dependent Resistor".

Important note: The photoresistor has a resistance value of $0 - > 1\text{M}\Omega$ (in complete darkness). A maximum value of 15,000 can be read off on the TXT Controller using software.



Environmental sensor



The sensor, which is mounted on a board in the housing, is used to measure gas, air pressure, humidity and air temperature. The module is connected to the TXT using a ribbon cable.

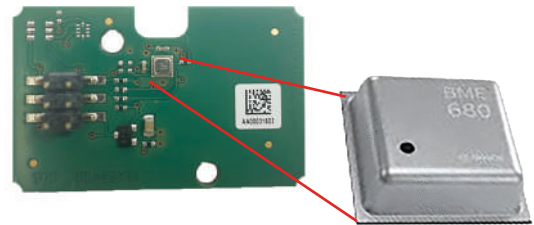

The data are measured continuously and saved in a CSV file that can be opened using a program like Excel. You can view the values in the fischertechnik Cloud.

The images show a section of the environmental station dashboard.

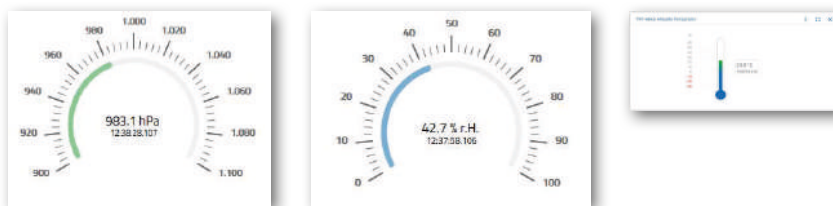

Colour sensor

Colour sensors are used, for instance, in automation technology. They are used to check colour or a colour print, for instance, to ensure that the right components are installed. The fischertechnik colour sensor transmits white light that is reflected with differing intensity by different coloured surfaces. Phototransistors are used to measure the intensity of the reflected light and output it as a voltage value between 0 V and 9 V. The measured value is dependent on the ambient brightness and the distance between the sensor and coloured surface. It is connected by three cables. The red cable is sired to the 9V output of the TXT Controller, the green cable to the ground, and the black cable is connected to a universal input. This measured value is output in the software as a number value between 0 and 9,000.





TXT 4.0 Controller

The complete performance data of the TXT 4.0 controller can be viewed at www.fischertechnik.de/txt40controller; the most important features are:

- Processor: Arm® dual Cortex®-A7 650 MHz + Cortex®-M4
- Storage capacity: 512 MB DDR3 RAM, 4 GB eMMC
- Storage extension: Micro SD card slot
- Colour touch display: 2.4", 320x240 Pixel, capacitive (allows gestures)
- Flat design, dimensions: 90x90x17.5mm
- 8 universal inputs: Digital/analogue 0-9VDC, analogue 0-5 kΩ /
- 4 quick counter inputs: Digital, frequency up to 1 kHz
- 4 motor outputs 9V/250mA (max. 1 A): Infinitely variable speed, short-circuit-proof, alternatively 8 individual outputs, e.g. for LEDs
- 3 servo outputs (max. 2A), short circuit resistant
- Combined Bluetooth / WiFi wireless module: Bluetooth 5.0 (BR, LE & EDR), WLAN Dual band 2.4 GHz and 5 GHz 802.11 a/b/g/n
- USB 2.0 client: Mini USB port for connection with the PC
- USB Host port: USB-A port, for instance for fischertechnik USB camera or USB sticks
- Camera interface: via USB host, Linux camera drivers integrated in the operating system
- 2x 6-pole connector strip: to expand the inputs and outputs (up to 9 TXT 4.0 Controllers can be connected) and I²C interface
- Integrated speaker for playing sounds (WAV files)
- Linux-based open source operating system, firmware update via the cloud, USB stick or micro SD card
- Programming with ROBO Pro Coding (graphic and Python), C/C++ Compiler (not included)
- Additional programming options via REST interface. Available output voltages 9V, 5V and 3.3V. Power supply: 3.45 mm 9V DC port or fischertechnik 2.5 mm ports (for battery pack). Incl. USB connection cable and 6-pole expansion cable.

NFC tags NTAG213 22mm

Each workpiece has its own unique ID and displays the following data: Status, colour and timestamp from delivery to dispatch. These are saved in the tags. The tags are integrated in the workpiece and therefore can be used directly.



NFC reader PN532 V3

This component is used to read and write the NFC tags. The production view of the NFC/RFID reader displays the workpiece data and can be used to read or delete workpieces manually. The raw data of the NFC tags can be read using a standard NFC app from mobile devices with NFC readers. The NFC reader is connected to an I²C port of the TXT 4.0 Controller.

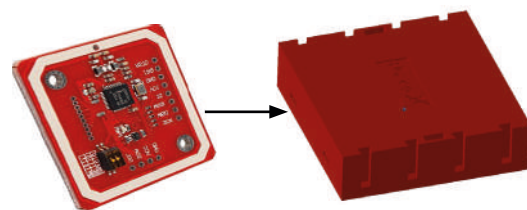

Layout plans

Layout plan for the vacuum gripper

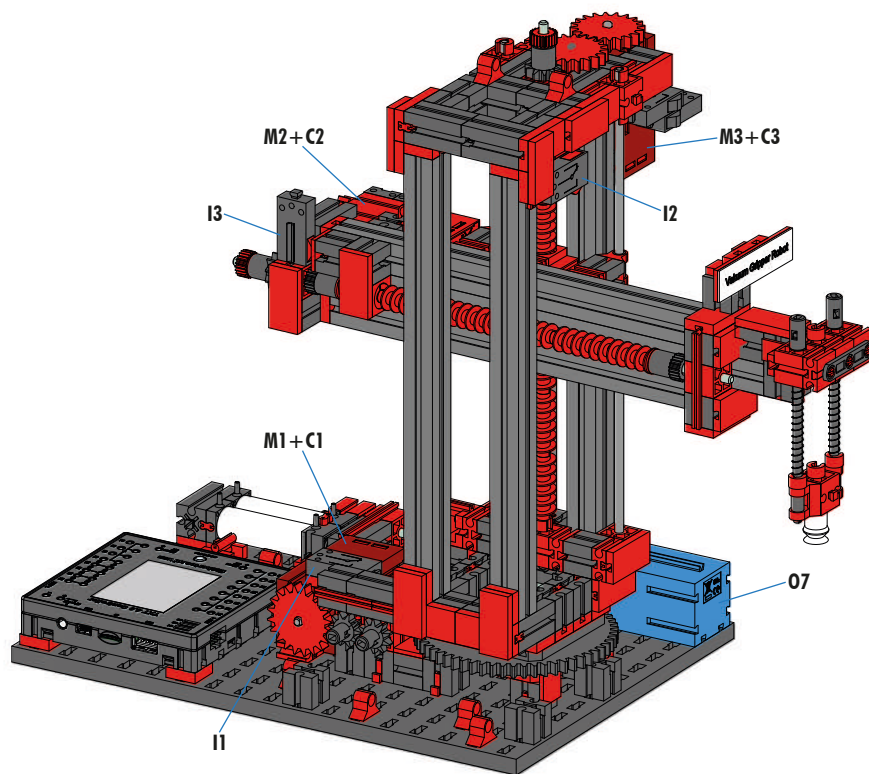

Not pictured: O8



TXT 4.0-Controller
Extension 2

Number	Function	Input/output
1	Turn reference switch	I1
2	Reference switch vertical	I2
3	Reference switch horizontal	I3
4	Phototransistor - DPS	I7
5	Colour sensor - DPS	I8
6	Turn encoder	C1
7	Encoder vertical axis	C2
8	Encoder horizontal axis	C3
9	Phototransistor - DPS	C4
10	Turn motor	M1
11	Motor vertical	M2
12	Motor horizontal	M3
13	Compressor	O7
14	Valve	O8

Layout plan for the automated high-bay warehouse

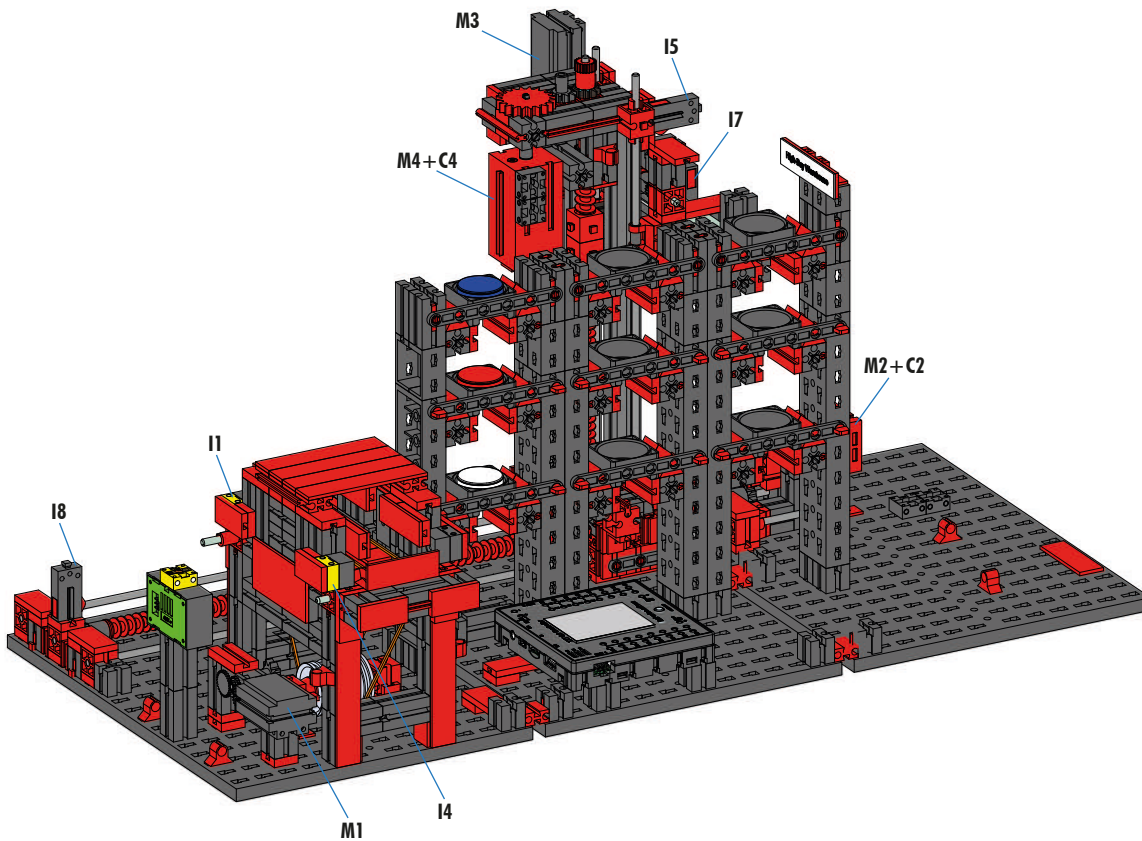

not pictured; I6

Number	Function	Input/output
1	Exterior phototransistor	I1
2	Interior phototransistor	I4
3	Horizontal reference switch	I5
4	Rear boom reference switch	I6
5	Front boom reference switch	I7
6	Vertical reference switch	I8
7	Horizontal encoder	C2
8	Vertical encoder	C4
9	Conveyor belt motor	M1
10	Motor horizontal	M2
11	Boom motor	M3
12	Motor vertical	M4



TXT 4.0-Controller
Extension 1

Layout plan for the multi processing station with furnace

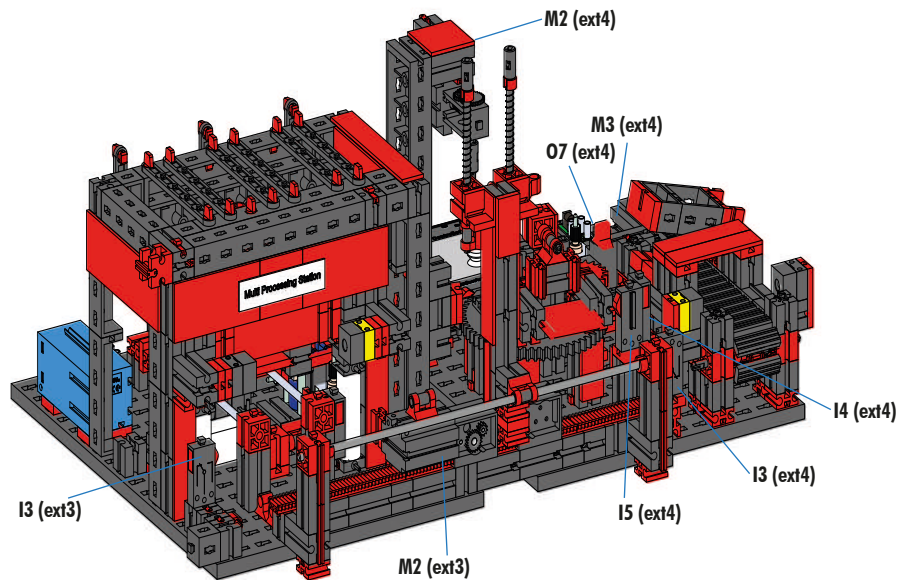

Not pictured:

extension 4: I1, I2, M1, O8

extension 3: I1, I2, I5, M1, O5, O6, O7, O8



TXT 4.0 Controller
Extension 3, 4

Number	Function	Input/output
1	Rotating assembly reference switch (suction cup position)	I1 (extension 4)
2	Rotating assembly reference switch (saw position)	I2 (extension 4)
3	Rotating assembly reference switch (suction cup position)	I3 (extension 4)
4	Phototransistor at end of conveyor belt	I4 (extension 4)
5	Vacuum cup reference switch (rotating assembly position)	I5 (extension 4)
6	Rotating assembly motor	M1 (extension 4)
7	Motor saw	M2 (extension 4)
8	Conveyor belt motor	M3 (extension 4)
9	Ejector valve	O7 (extension 4)
10	Compressor	O8 (extension 4)
11	Insert peel reference switch	I1 (extension 3)
12	Remove peel reference switch	I2 (extension 3)
13	Suction cup reference switch (furnace position)	I3 (extension 3)
14	Phototransistor	I5 (extension 3)
15	Peel motor	M1 (extension 3)
16	Suction cup motor	M2 (extension 3)
17	Vacuum valve	O5 (extension 3)
18	Lowering valve	O6 (extension 3)
19	Furnace door valve	O7 (extension 3)
20	Furnace lights	O8 (extension 3)

Layout plan for the sorting line with colour detection

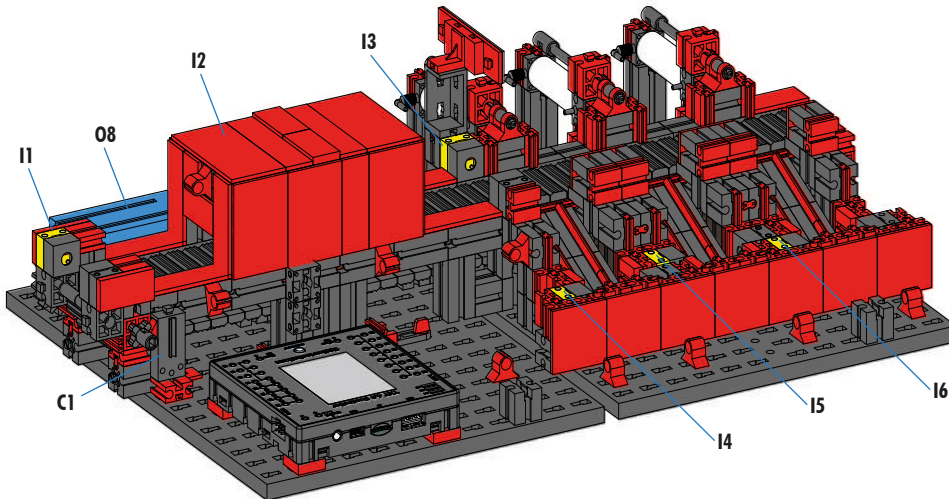

Not pictured: M1, O5, O6, O7

Number	Function	Input/output
1	Colour sensor phototransistor	I1
2	Colour sensor	I2
3	Ejector phototransistor	I3
4	White phototransistor	I4
5	Red phototransistor	I5
6	Blue phototransistor	I6
7	Pulse button	C1
8	Conveyor belt motor	M1
9	Valve ejection white	O5
10	Valve ejection white	O6
11	Valve ejection white	O7
12	Compressor	O8



TXT 4.0-Controller
Extension 5

Layout plan for the environmental station with monitoring camera



Environmental sensor



Photoresistor

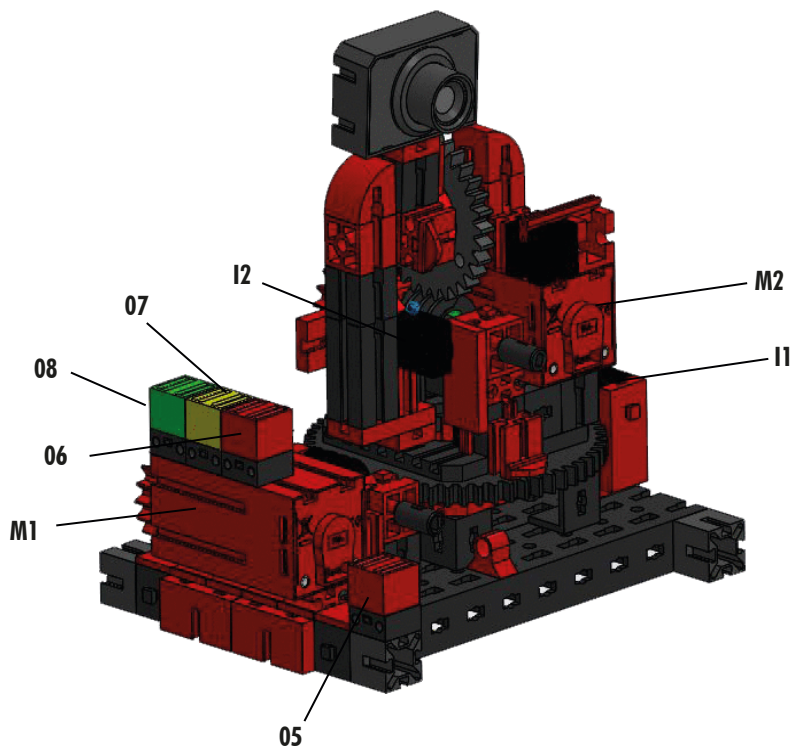
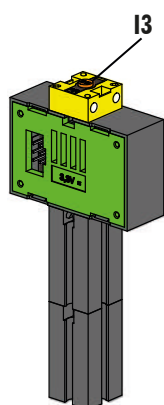

TXT-Controller 0
Master

Number	Function	Input/output
1	Turn camera reference switch	I1
2	Lift/lower camera reference switch	I2
3	Phototransistor	I3
4	Turn encoder	C1
5	Lift/lower encoder	C2
6	Turn motor	M1
7	Lift/lower motor	M2
8	Red camera LED	05
9	Red LED	06
10	Yellow LED	07
11	Green LED	08

Layout plan for the input / output station with colour detection and NFC reader

The controllers TXT 0 and TXT 2 are used to connect the input / output station.

The NFC reader is connected to Controller TXT 5 via an I²C port.

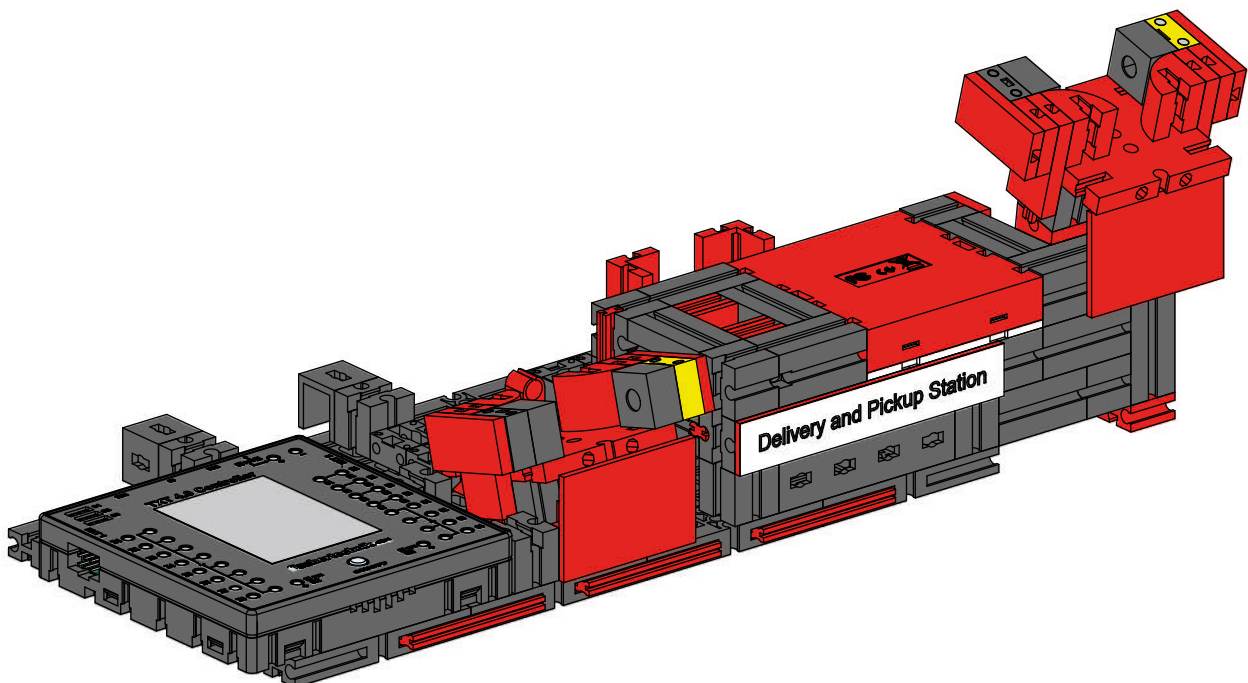

System calibration in the fischertechnik Node-Red Dashboard for the Training Factory

If items in the individual factory modules are no longer correct, or if the colour sensors need to be recalibrated, these steps can be carried out in the fischertechnik Node-Red Dashboard for the Training Factory.

The program “FactoryCalib” on the TXT 4.0 Controller must be started for calibration.

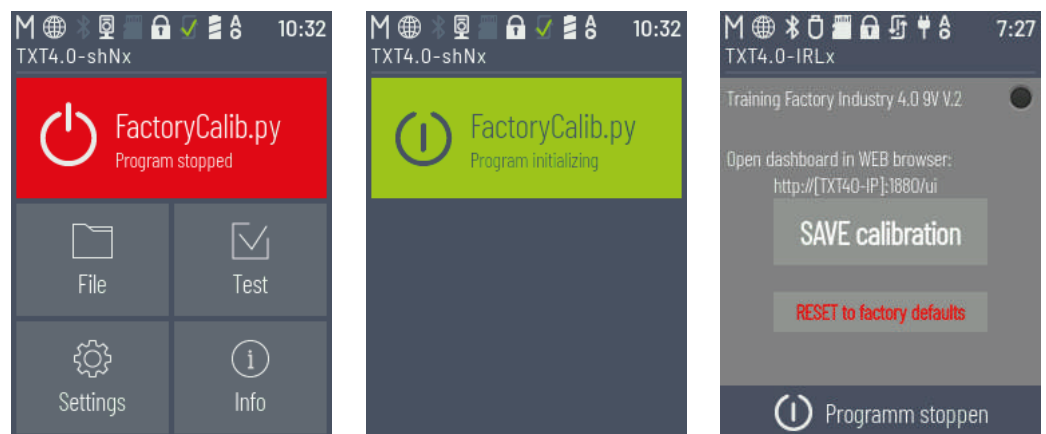

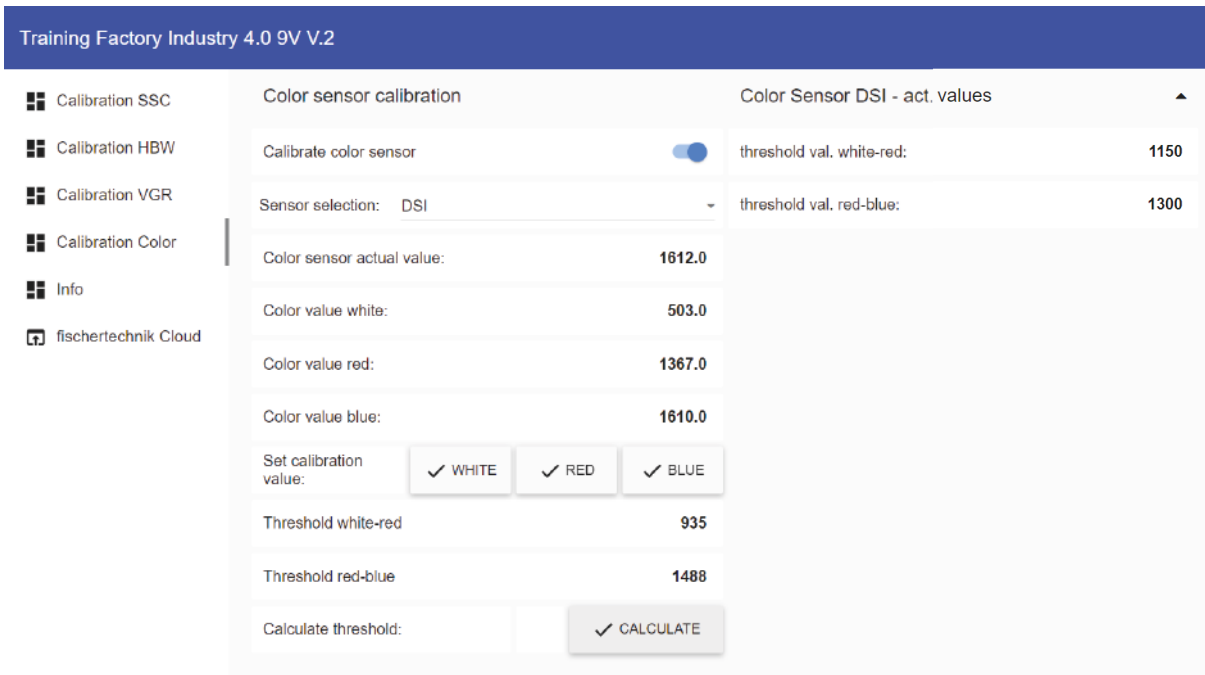

Calibrating the colour sensors:

The colour sensors are calibrated in the **“Colour sensor calibration”** window in the dashboard under **“Calibration Colour”**.



The process is started by activating **“Calibrate colour sensor”**  and selecting the relevant colour sensor. Here is an example using **“DSI”**.

- DSI stands for the colour sensor in the input / output station
- SLD stands for the colour sensor in the sorting station

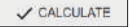
First, place the white workpiece in the centre of the sensor and confirm the value by clicking . Then, confirm the red workpiece by clicking  and finally confirm the blue workpiece by clicking . Then click  to calculate the threshold values.

Note: At the end, do not forget to deactivate **“Activate pos. move”** once again  and save the current calibration values in the **“FactoryCalib”** program on the TXT 4.0 Controller using the button .

The colour sensors in the sorting station (SLD) are calibrated in the same way, however each workpiece is placed on the start of the belt for measurement in this case. The conveyor belt then transports the workpiece past the colour sensor to the light barrier downstream of the colour sensor.

Calibrating a position in the sensor station with camera (SSC):

The camera positions in the sensor station with camera (SSC) are calibrated in the windows **“Move to position”**, **“Position Centre”** and **“Position HBW”** in the dashboard under **“Calibration SSC”**

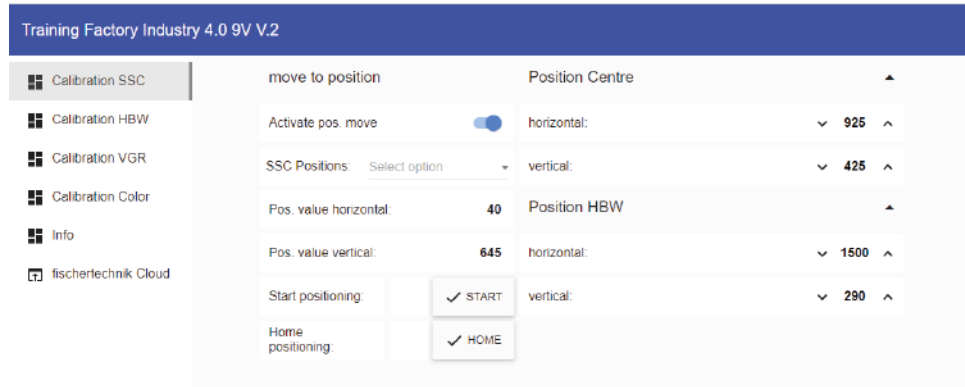

The process is started by activating **“Activate pos. move”** .

Then, one of the two positions **“Centre”** (central position facing the vacuum gripper) or, as shown here, **“HBW”** (position facing the high-bay warehouse) can be selected.

When you click , the camera first moves to the reference position (0/0) and then to the position **“HBW”**.

Test both positions in this manner.

If one of the positions is not correct, this can be corrected in the windows **“Position Centre”** and **“Position HBW”**. Then the test should be repeated.

Repeat this process until both positions are correct.

You can click to move to the reference position (0/0).

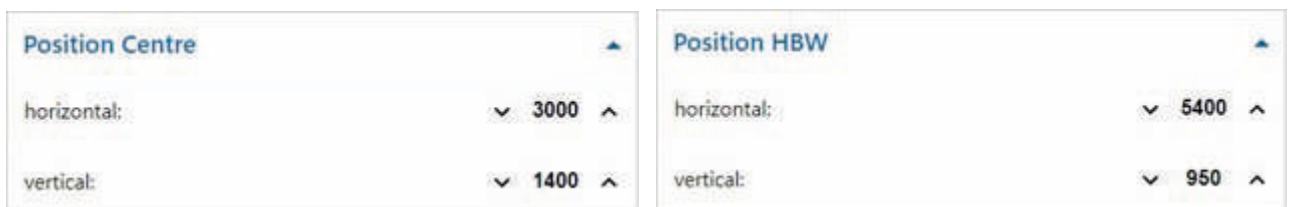

Note: At the end, do not forget to deactivate **“Activate pos. move”** once again  and save the current calibration values in the **“FactoryCalib”** program on the TXT 4.0 Controller using the button .

Calibrating a position for the vacuum gripper (VGR):

The positions of the 3 axis robot in the vacuum gripper station (VGR) are calibrated in the dashboard under **“Calibration VGR”**. The window **“move to position”** and 13 windows for the positions

**“Position Colour Reader”,
 “Position DSI collect”,
 “Position DSI discard”,
 “Position DSO collect”,
 “Position DSP discard”,
 “Position HBW collect”,
 “Position HBW discard”,
 “Position MPO”,
 “Position NFC”,
 “Position NiO”,
 “Position SLD white”,
 “Position SLD red” and
 “Position SLD blue” are available.**

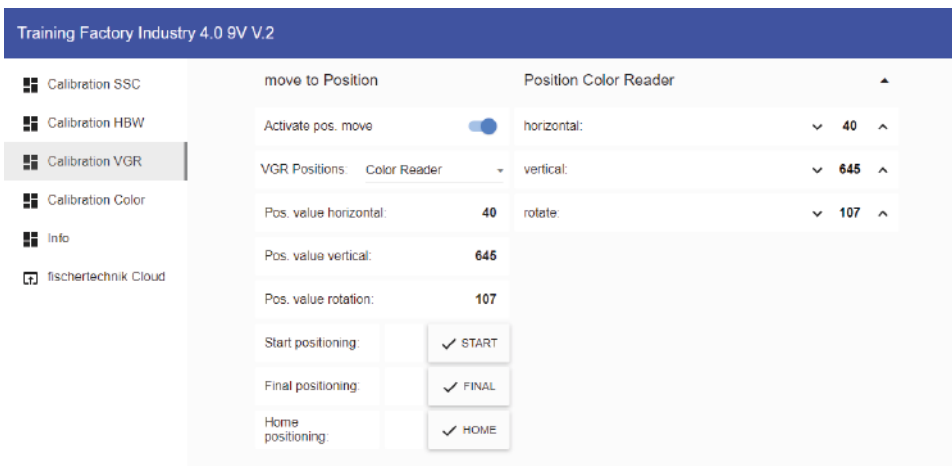

The process is started by activating **“Activate pos. move”**.
 Then, one of the positions, such as the position **“DSO discard”** can be selected.

If you click **START**, the 3-axis robot will first move to the reference position (0/0/0) and then to a position above (offset by the value Offset) the position **“DSO discard”**.

If you click **FINAL**, it will move to the final position and then back to the reference position (0/0/0).

Test all 13 positions in this manner.

Position DSO	
horizontal:	▼ 2070 ▲
vertical Collect:	▼ 1480 ▲
vertical Discard:	▼ 1480 ▲
rotate:	▼ 950 ▲
vertical Offset:	▼ 200 ▲

If one of the positions is not correct, it can be corrected in the windows for the positions, in this example the **“Position DSO”**. Then the test should be repeated. Repeat this process until all positions are correct.

You can click  to move to the reference position (0/0/0).

Note: At the end, do not forget to deactivate **“Activate pos. move”** once again  and save the current calibration values in the **“FactoryCalib”** program on the TXT 4.0 Controller using the button .

Calibrating a position in the automated high-bay warehouse (HBW):

The positions of the storage and retrieval devices in the automated high-bay warehouse station (HBW) are calibrated in the dashboard under **“Calibration HBW”**. The window **“move to position”** and 5 windows for the positions

“Position Belt”,
“Position Rack”
 with the offset for the rack,
“Position Rack Row A”, **“Position Rack Row B”** and **“Position Rack Row C”**.

Position Belt	▼
Position Rack	▼
Position Rack Row A	▼
Position Rack Row B	▼
Position Rack Row C	▼

Only the positions Rack A1, Rack B2 und Rack C3 are approached and calibrated in the warehouse. The other 6 position values are calculated from these.

move to Position	
Activate pos. move	<input checked="" type="checkbox"/>
HBW Positions:	Select option ▾
Pos. value horizontal:	40
Pos. value vertical:	645
Start positioning:	<input checked="" type="checkbox"/> START
Final positioning:	<input checked="" type="checkbox"/> FINAL
Start offset:	<input checked="" type="checkbox"/> OFFSET
Home positioning:	<input checked="" type="checkbox"/> HOME

The process is started by activating **“Activate pos. move”** .

Then one of the positions, such as the position **“Rack C3** (Position C3 in the warehouse) can be selected.

When you click START, the storage and retrieval device first moves to the reference position (0/0/boom at rear) and then to the position **“Rack C3”** in front of the warehouse.

When you click FINAL, the boom extends into the warehouse.

When you click OFFSET, the storage and retrieval device moves up by the value Offset to pick up a pallet.

If you click OFFSET once again, the storage and retrieval device moves back down by the offset, then the boom is retracted and it moves back to the reference position (0/0/boom at rear).

Test all 3 positions in the warehouse (A1, B2, C3) and the position on the belt in this manner.

Position Rack	▲
vertical Offset:	▼ 180 ▲
Position Rack Row C	▲
C3 horizontal:	▼ 1965 ▲
C3 vertical:	▼ 845 ▲

If one of the positions is not correct, this can be corrected in the windows for positions - **„Position Rack Row C”** (Position Rack C3). Then the test should be repeated.

Repeat this process until all positions are correct.

You can click to move to the reference position (0/0/boom at rear).

Note: At the end, do not forget to deactivate **“Activate pos. move”** once again  and save the current calibration values in the “FactoryCalib” program on the TXT 4.0 Controller using the button .

Updating programs

Upon delivery of the Training Factory 4.0 9V V.2, the current available versions of the programs **“FactoryMain”** and **“FactoryCalib”** are copied to the main controller in the Training Factory.

Since the two programs **“FactoryMain”** and **“FactoryCalib”** are subject to ongoing development, we recommend always copying the current version of the programs to the TXT 4.0 Controller.

This section describes how to update the two programs.

The **App ROBO Pro Coding** and an internet connection are required for the update.

Proceed as follows:

1. Start ROBO Pro Coding and import the relevant program, e.g. **“FactoryMain”** or **“FactoryCalib”** from the fischertechnik Gitlab:

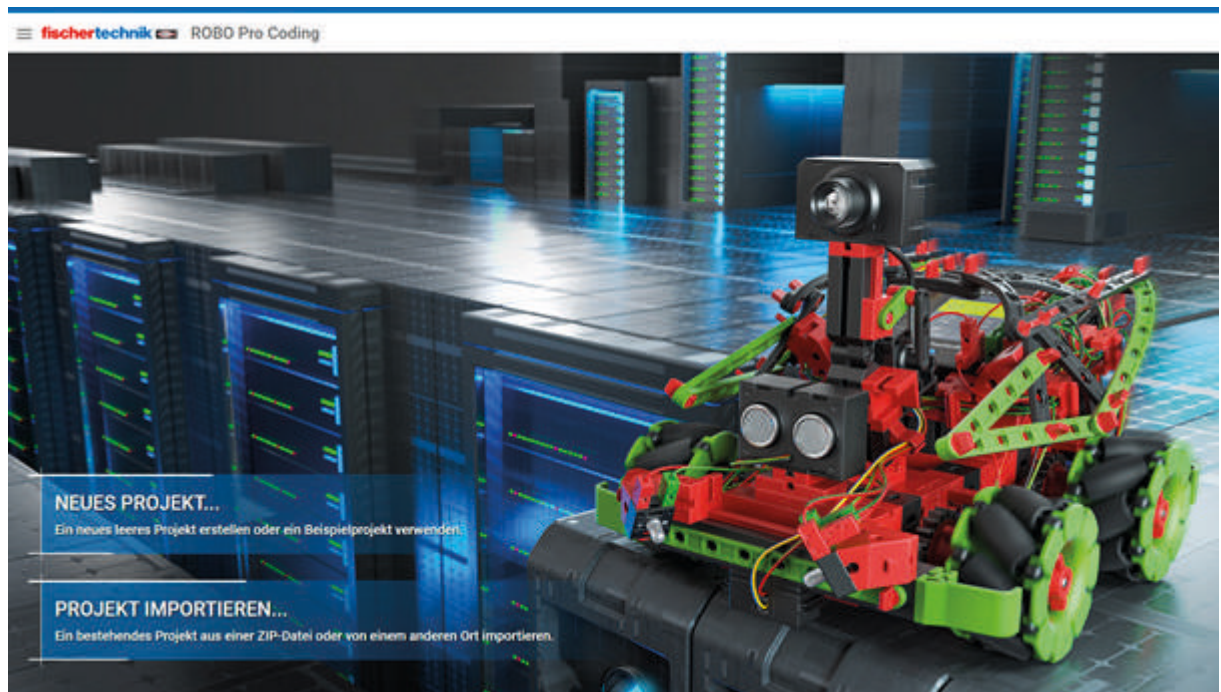

☰ **fischertechnik**

Voreinstellungen

> Einstellungen

Projekt

> Neu

> Importieren

Hilfe

> Dokumentation

> Datenschutzrichtlinie

> Impressum

Einen Ort auswählen, von dem das Projekt importiert werden soll

 Lokal	 GitLab  Fischertechnik GitLab
--	---

ABBRECHEN NÄCHSTE

Ein Projekt aus GitLab importieren

Persönlicher Zugriffstoken
 Persönlicher Zugriffstoken

Um private Speicherorte zu sehen, brauchst du einen persönlichen Zugriffstoken mit Zugriffsrechten für die API.

1. [Melde dich bei GitLab an](#).
2. Klicke in der oberen rechten Ecke auf deinen Avatar und wähle Einstellungen.
3. Wähle im Menü Benutzereinstellungen die Option Zugriffstoken.
4. Wähle einen Namen und ein optionales Ablaufdatum für den Token aus.
5. Wähle die gewünschten Geltungsbereiche aus.
6. Klicke auf die Schaltfläche Persönlichen Zugriffstoken erstellen.
7. Bewahre den persönlichen Zugriffstoken an einem sicheren Ort auf. Sobald du die Seite verlässt oder aktualisierst, kannst du sie nicht mehr aufrufen.

ABBRECHEN

VORHERIGE

NÄCHSTE

Ein Projekt aus GitLab importieren

Q FactoryMain

 Training models / FactoryMain

ABBRECHEN

VORHERIGE

IMPORTIEREN

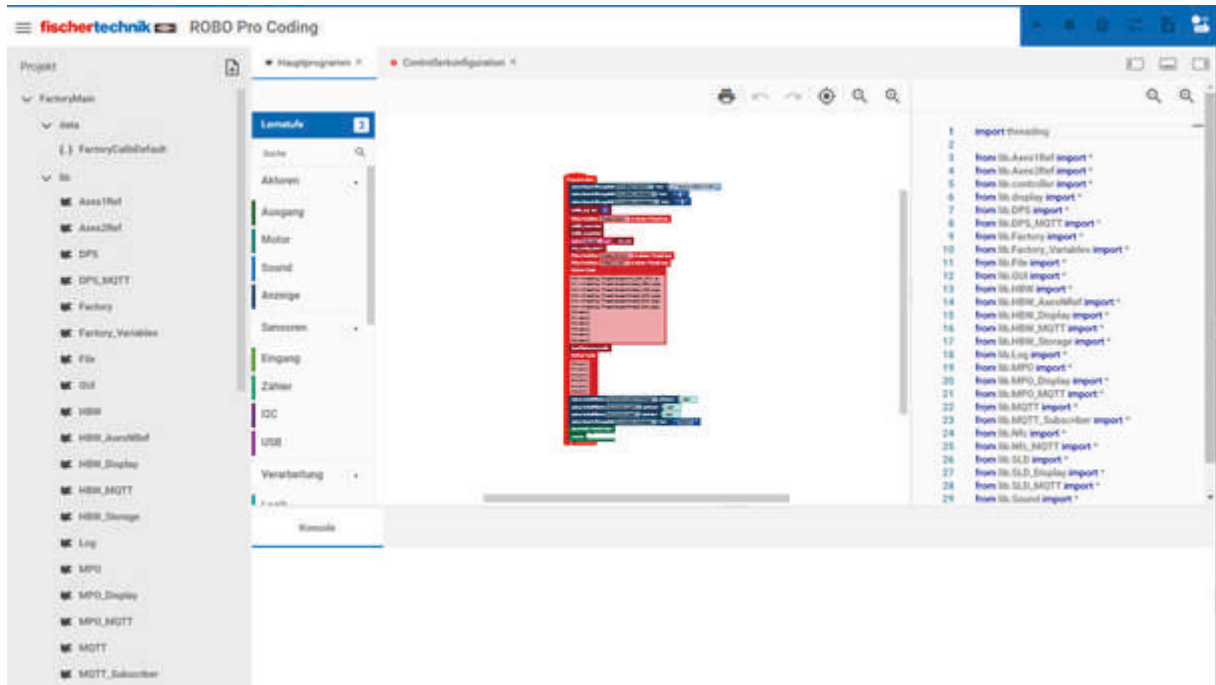

2. Connect the ROBO Pro Coding app and TXT 4.0 Controller



?

Controller verbinden

IP-Adresse des Controllers *

192.168.0.100
▼

API-Schlüssel *

8e9URb

ABBRECHEN

VERBINDEN



3. Copy the program to the TXT 4.0 Controller



Accessories		
1	9x Werkstück mit NFC-Tag 9x workpiece with NFC tag	174 622 weiß / white 174 624 rot / red 174 626 blau / blue 174 623 weiß / white 174 625 rot / red 174 627 blau / blue 174 207 174 628
2	9x Werkstückträger 9x workpiece carrier	160 551
3	Schlüsselanhänger mit NFC-Tag Key chain with NFC-tag	174 208
4	Karte mit NFC-Tag Card with NFC-tag	174 208
5	Mini-USB-Kabel für TXT 4.0 Controller Mini-USB-cable for TXT 4.0 Controller	134 867